

Trapped Key Interlocks



Product Catalogue



Castell

The Future of Safety is Here



 Castell Offices

 Castell Installations

We Keep You Safe at Work Worldwide

Contents

Why Choose Castell?	4
Trapped Key Interlocking	5
Machine Guarding	6
Switchgear	7
Isolation	8
Key Exchange	38
Access Control	46
Keys & Accessories	60
Glossary	66
Product Overview	68

Isolation 8

<i>Power Isolation (10)</i>
<i>Control Switching (12)</i>
<i>Solenoid Controlled Switching (16)</i>
<i>Mechanical Isolation (20)</i>
<i>Time Delay Interlocking (30)</i>
<i>Motion Sensing (34)</i>
<i>Valve Interlocking (36)</i>

Key Exchange 38

<i>Key Exchange Boxes (40)</i>

Access Control 46

<i>Part Body Access (48)</i>
<i>Full Body Access (54)</i>

Keys & Accessories 60

<i>Keys (62)</i>
<i>Flip Cap (64)</i>

Why Choose Castell?

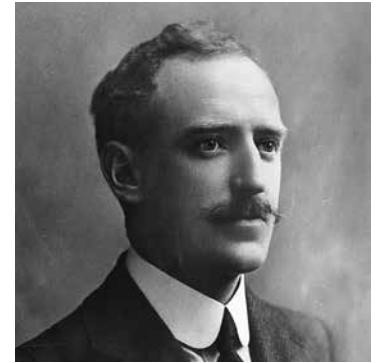

Founder:
James Harry Castell
1880 - 1953

- Expertise in providing the best possible trapped key solution whatever the industry
- 90 years of experience protecting people and assets in industry
- High quality innovative products
- ISO 9001: 2008 accreditation
- Global team dedicated to providing technical support and assistance in selecting the correct solution
- The widest range of rugged and reliable trapped key interlock products globally
- The ability to produce customised solutions to meet the demands of your specific application

Castell Safety International has been at the forefront of trapped key interlocking since 1922 when our founder, James Harry Castell, designed the first interlocking systems to protect the people and assets during the electrification of London. Today Castell, from its five global locations, designs and manufactures the world's widest range of industrial safety interlocking systems ensuring that industry can operate safely around the world.

Our interlocking systems are designed to be robust, durable and are proven in all types of operating environments that meet the demands of the harsh locations our customers operate in. Above all, they are designed to protect personnel and assets where the risk of injury and damage are high.

Castell's approach to working with customers is deeply rooted in understanding the safety issues found in modern industrial environments. Recognising how safety impacts operations is an important step to designing systems that deliver fast safe access ensuring that efficiency is maintained and output rates are secured.

Castell's scope of supply extends beyond the standard product range in this catalogue. Product hybrids are developed by our in-house design team.

Trapped key interlocking ensures that a process is followed and cannot be circumvented or short cut. The transfer of a key ensures that wherever personnel find themselves, in either starting or shutting down operations, they can be assured that they are safe.

There are three simple steps in designing a trapped key system, what is being isolated, how many access points are there and what type of access is required.

A key is used to start the process and remains trapped whilst the machine is running. The only way to remove the key is to isolate the hazard.

This key is then used to gain access to the dangerous area and remains trapped in position while the gate or door is opened. The key can only be removed when the gate or door has been shut. In this way the key is either trapped when the machine is running and access cannot be gained, or the key is trapped while access is gained and the machine cannot be started.

The three points of trapped key interlocking

1 Isolation

2 Key Exchange

3 Access Control

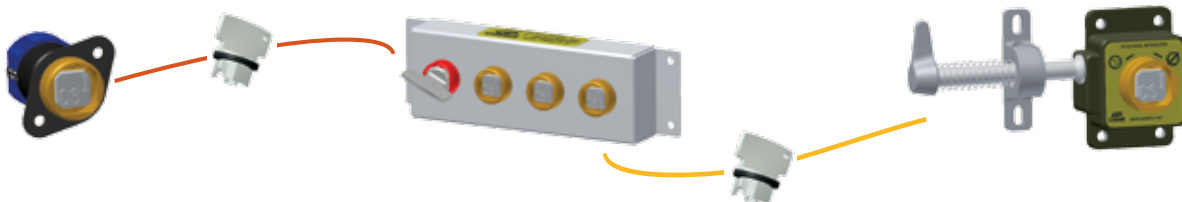

Designing interlock systems

To design an interlock system there are a number of key questions that need to be addressed. These are:

- What is the operational flow to start and stop equipment?
- What is being isolated?
- Is there more than one system that needs to be isolated to make access safe?
- Is there a time delay required for safe access?
- How many access points are there?
- What is the type of access? Full body or part body?
- Severity of the possible injuries?
- What is the possibility of avoiding the hazard?
- What is the nature of the hazards?
- What are the energy sources present?
- What is the operating environment?

Machine Guarding

Today's production environment is very demanding. Pressures on supply chain efficiency and output are major considerations when developing manufacturing systems. Castell's approach to delivering solutions for machine guarding applications is to ensure that fast safe access can be gained. This means that efficiency is maintained whilst safety is not compromised.

Through this approach and the design of innovative products Castell systems can be found in a vast range of applications across the globe. Working closely with industry Castell has ensured that products are available with the correct specifications, such as materials and finishes, to ensure a reliable operation for every environment.



Some of the areas where Castell products can be found are:



- Food and Beverage
- Aggregates and Mining
- Pharmaceutical and Chemical
- Paper, Pulp and Wood
- Steel, Aluminium and Precious Metal
- Automotive and Electronics
- Water and Recycling

Typical application areas:

Robot cells | Conveyors | Palletisers | Gas Turbines | Freezer Rooms | Automated Warehouse | Power Press | Spray Booths
Industrial Mixers | Pressure Vessels | Recycling | Rotating Machinery | Mixers and Blenders | Crushers | Bottling | Packaging

The original Castell interlock concept dates from 1922 and was developed for the electrical switchgear industry. This remains today a very important part of the Castell product portfolio. Castell delivers solutions across the electrical network from power stations to transmission equipment and from sub stations to incomer rooms. The ability to work across HV, MV and LV means that a Castell system can be used as a single solution to provide personnel safety and ensure equipment is used in the correct mode.

Our range of products has been developed over 90 years to provide the industry with interlocks of high quality and integrity. Working closely with key switchgear manufacturers has enabled Castell to produce interlocks designed specifically for use on the leading manufacturers own breakers, isolators, disconnectors and earth mechanisms.

Castell products are available in a range of materials and finishes, to ensure the correct specification interlocks. High temperature locks for use on electrostatic precipitators, stainless steel and weatherproof locks for use in sub-stations, chrome plated locks for areas where aesthetics are important and brass as standard for locks in dry, clean, non-corrosive environments.



Castell products are used in the following areas:



- Wind Turbine Isolation & Earthing
- Rail Electrification Systems
- Electrostatic Precipitators
- UPS Systems
- LV Distribution & Busbar Systems
- HV Transmission & Distribution Sub Stations
- Transformer Isolation & Earthing Systems

Castell has developed products to suit the following companies' equipment:

ABB | Alstom | Terasaki | Schneider Electric | Siemens | Hawker Siddeley | George Ellison



Through development and experience Castell has a number of methods to isolate switchgear or machinery. This can be done mechanically, through control circuitry or through power circuitry.

In complex operations a number of isolations may need to occur to ensure that switchgear or machinery is safe to work on.

The isolation keys are then used to either gain direct access, are transferred to a time delay unit or for multiple entry points access through an exchange box.

Isolation

Power Isolation	10
Control Switching	12
Solenoid Controlled Switching	16
Mechanical Isolation	20
Time Delay Interlocking	30
Motion Sensing	34
Valve Interlocking	36



Power Isolation



KSD32-FSB-F-CC6-C/O2

KSD - Switch Disconnecter

- Key driven switch disconnecter for the isolation of currents/motors
- Complete with 6 main poles plus 2 auxiliary early break contacts
- Manufactured from either brass or stainless steel
- Suitable for use in standard or harsh, corrosive environments
- Panel or surface mounting
- IP65 rated lockable mild steel enclosure (surface mount version)
- Available with FS or Q type lock portions
- 32 A standard version
- 63, 125 and 250 A versions available upon request

Application

The KSD is designed to operate as part of an integrated safety system, controlling access to hazardous areas. Typical machinery using the KSD range are motor driven, high risk applications where complete isolation of the power supply is required before access is granted.

The removal of the key in the KSD changes the condition of the electrical supply to the machine to a safe condition. This key can be removed and used to unlock the door via AIE access interlock.

The guard can only be opened when the electrical supply has been switched into a safe condition. The machine cannot be restarted until the door is closed and the key is removed and taken to the KSD.

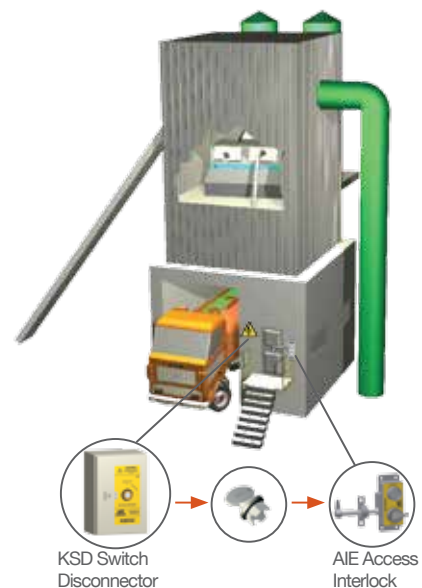

Order Information

	Product Type	1	2	3	4	5	6	7	8	9
Part Number	KSD									
Example	KSD	32	FS	B	F	CC	6	C/O	2	TBA

1	Isolation	32 A (UL&CSA:30A), standard (63 A, 125 A or 250 A available on request)
2	Lock portion type	FS ⁽¹⁾ / Q ⁽¹⁾
3	Material	B = Brass / S = Stainless steel
4	Mounting	P = Panel mount (back of board) F = Front of board mount, enclosure
5	Main contacts arrangement in normal position (key in)	CC = NC arrangement (all contacts closed, standard)
6	Number of main contacts	6, standard
7	Auxiliary contacts arrangement in normal position	C/O = 1NO/1NC, standard
8	Number of auxiliary contacts	2, standard
9	Lock portion symbol	FS ⁽¹⁾ up to 3 characters / Q ⁽¹⁾ up to 6 characters

⁽¹⁾ Please see our glossary on pages 66-67 for more information

Please see our user manuals for more technical details and drawings, as well as mounting and maintenance information.

What our customers say

"We had a problem with the old system, and thanks to Castell's robust products we have addressed it. Their customer service has also been first class."

Jason Waltham, Ideal Heating

Control Switching



Salus20 - Key Isolator Switch

- Trapped key isolator switch
- Capable of switching up to 20 A
- Combines an integrated flush mounted lock with sliding lock cover
- Stainless steel sealed enclosure
- Ergonomically designed to avoid collecting and trapping dirt
- Suitable for wash down environments
- Fitted with stainless steel glands
- Suitable for harsh or corrosive environments and heavy duty use

SALUS20-C/O4

Application

A typical application of Salus20 isolator key switch is machine guarding. It is usually used in combination with an access interlock such as the Salus for part body access or an access interlock with an exchange key for full body access control such as AIE.

The Salus20 breaks the machine safety circuit, ensuring a machine is shut down when the key is turned and removed. The key can then be taken to the Salus automatic access interlock to enable access to the machine.

The machine cannot be restarted until the door is closed, the bolt is trapped in the access interlock and the key is removed and taken to the Salus20.

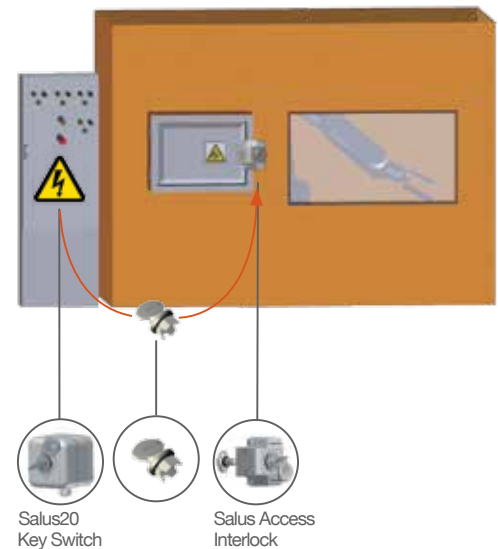

Order Information

	Product Type		1	2	3
Part Number	SALUS	20			
Example	SALUS	20	C/O	4	TBA

1	Contacts arrangement in normal position (key in)	C/O = NO/NC arrangement (contacts closed/open) CC = NC arrangement (all contacts closed)
2	Number of contacts	4, standard
3	Lock portion symbol	Please advise (up to 3 characters for FS lock portion type ⁽¹⁾)

⁽¹⁾ Please see our glossary on pages 66-67 for more information

Please see our user manuals for more technical details and drawings, as well as mounting and maintenance information.

KS - Powersafe Electrical Switch



KS20-FSB-P-C/O4

- Key driven electrical switch
- Designed for machine control circuits
- Intended for short term, off load isolation usage
- Available with FS or Q type lock portions
- Manufactured from either brass or stainless steel
- Ideal for use in normal or harsh, corrosive environments and heavy duty use
- To be mounted into an existing panel or for surface mounting
- Polycarbonate IP65 rated enclosure (surface mount version)
- Available with 20 A as standard and 32 or 63 A upon request
- Supplied with gasket

Application

A typical application of KS powersafe electrical switch is machine guarding. It is usually used in combination with an access interlock such as the Salus for part body access or an access interlock with an exchange key for full body access control such as AIE.

The KS breaks the machine safety circuit, ensuring a machine is shut down when the key is turned and removed. The key can then be taken to the Salus automatic access interlock to enable access to the machine.

The machine cannot be restarted until the door is closed, the bolt is trapped in the access interlock and the key is removed and taken to the KS.

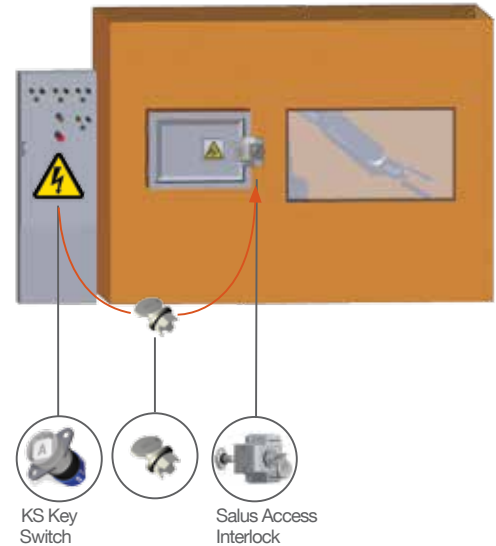

Order Information

	Product Type	1	2	3	4	5	6	7
Part Number	KS							
Example	KS	20	FS	B	P	C/O	4	TBA

1	Isolation	20 A, standard (32 and 63 A available on request)
2	Lock portion type	FS ⁽¹⁾ / Q ⁽¹⁾
3	Material	B = Brass / S = Stainless steel
4	Mounting	P = Panel mount (back of board) F = Front of board mount, with enclosure
5	Contacts arrangement in normal position (key in)	C/O = NO/NC arrangement (contacts closed/open) CC = NC arrangement (all contacts closed)
6	Number of contacts	4, standard
7	Lock portion symbol	FS ⁽¹⁾ up to 3 characters / Q ⁽¹⁾ up to 6 characters

⁽¹⁾ Please see our glossary on pages 66-67 for more information

Control Switching



KSE - Multi-key Powersafe Electrical Switch

- Multi-key controlled electrical switch
- Suitable for the isolation or switching of 20 A standard
- Intended for short term, off load isolation usage
- To be operated by suitably qualified personnel
- Mounting into an existing panel or for surface mounting
- IP65 rated mild steel enclosure (surface mount version)
- Available with FS or Q type lock portions
- Manufactured from either brass or stainless steel
- Ideal for use in standard or harsh, corrosive environments

KSE20-FSB-2S-F-D-C/O4

Application

A typical application of KSE multi-key powersafe electrical switch is machine guarding. It is usually used in combination with an access interlock such as the Salus for part body access or an access interlock with an exchange key for full body access control such as AIE.

A typical system will isolate machinery and control access to hazardous areas. Removing the power isolation key from the KSE unit changes the condition of the electrical supply to the machine to a safe condition and enables the release of the personnel keys. These keys are then used to unlock the AIE dual key access interlocks.

The guards can only be opened when the electrical supply has been switched into a safe condition and only once all the keys have been returned to the KSE can the machine be restarted.

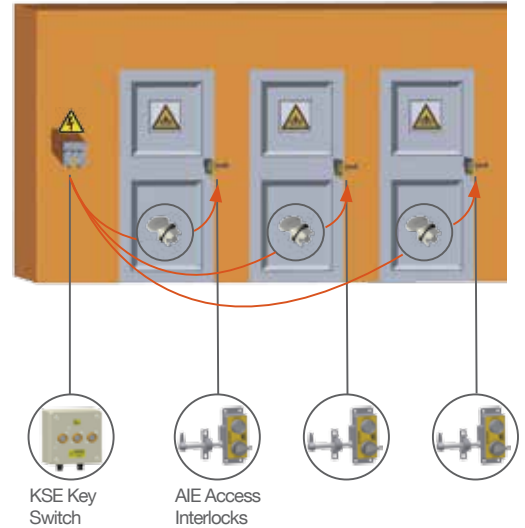

Order Information

	Product Type	1	2	3	4	5	6	7	8	9
Part Number	KSE									
Example	KSE	20	FS	B	2S	F	D	C/O	4	TBA

1	Isolation	20 A, standard
2	Lock portion type	FS ⁽¹⁾ / Q ⁽¹⁾
3	Lock portion material	B = Brass / S = Stainless steel
4	Secondary lock portion(s)	1S / 2S / 3S / 4S / 5S or 6S = 1 / 2 / 3 / 4 / 5 or 6 secondary lock portions respectively
5	Mounting	P = Panel mount (back of board) F = Front of board mount, with enclosure
6	Key condition	E = Exchange key condition D = Double key condition (sequential removal of all keys)
7	Contacts arrangement in normal position (key in)	C/O = NO/NC arrangement (contacts closed/open)/ CC = NC arrangement (all contacts closed)
8	Number of contacts	4, standard (6 available on request)
9	Lock portion symbol(s): Please advise for each lock separately as for primary key/ lock symbol (controls the switch) and secondary key/lock symbol(s)	FS ⁽¹⁾ up to 3 characters / Q ⁽¹⁾ up to 6 characters

⁽¹⁾ Please see our glossary on pages 66-67 for more information

Please see our user manuals for more technical details and drawings, as well as mounting and maintenance information.

What our customers say

"We believe that the fitting of the special early make/late break switches has resolved the problem to Network Rail's satisfaction. The Network Rail project engineer operated each switch personally and was satisfied that the contacts were made for a longer arc of key movement than the standard switches and they are fitting protective covers to prevent accidental operation of the switches. [...] Please thank everyone at Castell for their co-operation with the design and manufacture of special switches."

Tom Fairhall, Allenwest Brighton



Solenoid Controlled Switching



S20-FSB-F-CC4-110A

KSS - Solenoid Controlled Switch

- Heavy-duty solenoid controlled key driven electrical switch interlock
- Intended to be used for the controlled isolation or switching of low current
- Used where a process can send a signal to release a key, e. g. a robot has to finish a cycle prior to isolation
- Should be used for short term, off load isolation
- Available with FS or Q type lock portions
- Mounting into an existing panel or for surface mounting
- IP65 rated mild steel enclosure (surface mount version)
- Manufactured from either brass or stainless steel
- Suitable for use in standard or harsh, corrosive environments

Application

A typical application of KSS solenoid controlled switch is machine guarding. It is usually used in combination with an access interlock such as the Salus for part body access or an access interlock with an exchange key for full body access control such as AIE.

The KSS breaks the machine safety circuit ensuring a machine is shut down. Once the machine has completed the cycle, an external signal is received by the solenoid, which is indicated by an illuminated LED. Activating the green button on the KSS will enable the key to be turned and removed ensuring the power is locked out. The key can then be taken to the AIE access interlock to enable access to the machine.

The machine cannot be restarted until the door is closed, the bolt is trapped in the AIE access interlock and the key is removed and taken to the KSS.

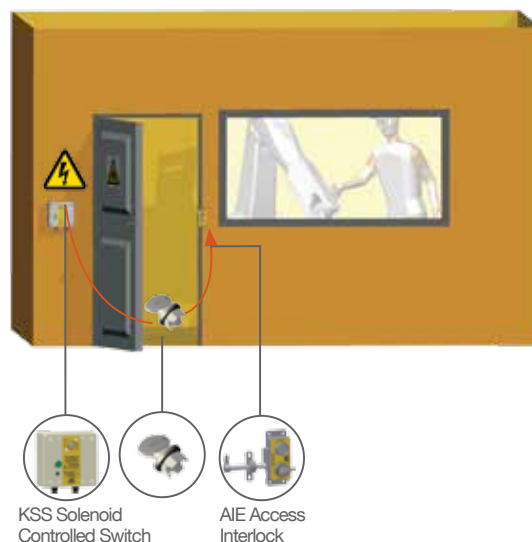

Order Information

	Product Type	1	2	3	4	5	6	7	8	9
Part Number	S									
Example	S	20	FS	B	F	CC	4	110	A	TBA

1	Isolation	20 A, standard
2	Lock portion type	FS ⁽¹⁾ / Q ⁽¹⁾
3	Lock portion material	B = Brass / S = Stainless steel
4	Mounting	P = Panel mount (back of board) F = Front of board mount, with enclosure
5	Contacts arrangement in normal position (key in)	C/O = NO/NC arrangement (contacts closed/open) CC = NC arrangement (all contacts closed)
6	Number of contacts	4 or 6, standard
7	Control voltage	110 / 24 / 240, standard
8	Current	VAC / VDC
9	Lock portion symbol	FS ⁽¹⁾ up to 3 characters / Q ⁽¹⁾ up to 6 characters

⁽¹⁾ Please see our glossary on pages 66-67 for more information

Please see our user manuals for more technical details and drawings, as well as mounting and maintenance information.



E20-FSB-3E-F-C/O4-110A

KSSE - Multi-key Solenoid Controlled Switch

- Solenoid controlled, multi-key electrical switch
- Intended to be used for the controlled isolation or switching of low current
- Used where the controlled isolation of a machine needs to take place, e. g. where a robot has to finish a cycle prior to isolation and where multiple entry points to the protected area are required
- Should be used for short term, off load isolation
- The solenoid is continuously rated and its position is electrically monitored
- Available with FS or Q type lock portions
- Mounting into existing panel or surface mounting
- IP65 rated steel enclosure (surface mount version)
- Manufactured from either brass or stainless steel

Application

A typical application of KSSE multi-key solenoid controlled switch is machine guarding. It is usually used in combination with an access interlock such as the Salus for part body access or an AIE access interlock with an exchange key for full body access control such as AIE.

The KSSE breaks the machine safety circuit, ensuring a machine is shut down once the isolation key is inserted and turned into the unit. Once the machine has completed the cycle, an external signal is received by the solenoid, which is indicated by an illuminated LED. Activating the green button on the KSSE will enable the personnel keys to be turned and removed ensuring the power is locked out. The keys can then be taken to the AIE dual key access interlocks to enable access to the machinery.

The machine cannot be restarted until all doors are closed, and all personnel keys returned to the KSSE.

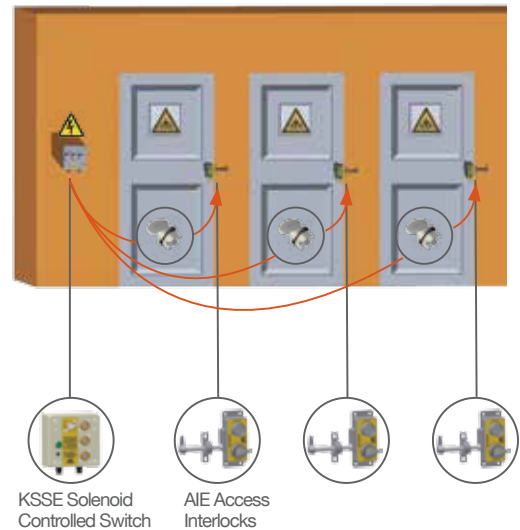

Order Information

	Product Type	1	2	3	4	5	6	7	8	9	10	11
Part Number	E											
Example	E	20	FS	B	3	E	F	C/O	4	110	A	TBA

1	Isolation	20 A, standard
2	Lock portion type	FS ⁽¹⁾ / Q ⁽¹⁾
3	Material	B = Brass / S = Stainless steel
4	Secondary lock portion(s)	1 / 2 or 3 secondary lock portions available as standard
5	Key condition	E = Exchange key condition D = Double key condition (sequential removal of all keys)
6	Mounting	P = Panel mount (back of board) F = Front of board mount, with enclosure
7	Contacts arrangement in normal position (key in)	C/O = NO/NC arrangement (contacts closed/open) CC = NC arrangement (contacts closed)
8	Number of contacts	4 or 6, standard
9	Control voltage	24 / 110 / 240, standard
10	Current	VAC / VDC
11	Lock portion symbols: Please advise for each lock separately as for primary key/lock symbol (controls the switch) and secondary key/lock symbol(s)	FS ⁽¹⁾ up to 3 characters / Q ⁽¹⁾ up to 6 characters

⁽¹⁾ Please see our glossary on pages 66-67 for more information

Solenoid Controlled Switching



KSUPSP-FSB-P-C/O4

KSUPS+ - Solenoid Controlled Switch

- Solenoid controlled trapped key interlock
- Primarily used in uninterruptable power supply (UPS) systems
- Ensures that access can only be gained once the UPS is in a safe condition
- Manufactured from either brass or stainless steel
- Ideal for use in standard or harsh, corrosive environments
- Supplied ready for mounting into an existing panel
- Comes with a multi-voltage range of input voltages: 24, 110 and 240 VAC or VDC

Application

A typical application of KSUPS+ solenoid controlled switch is the control of access to uninterruptable power supply (UPS) systems.

The key is released when the UPS system gives a signal to the KSUPS+ to energise the solenoid when it is in a safe state to allow access.

The key can then be taken to gain access to the protected area. The UPS cannot commence until the key is removed and taken to the KSUPS+.

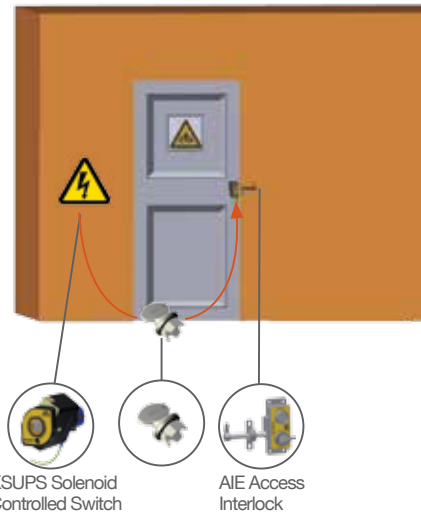

Order Information

	Product Type	1	2	3	4	5	6
Part Number	KSUPSP						
Example	KSUPSP	FS	B	P	C/O	4	TBA

1	Lock portion type	FS ⁽¹⁾ / Q ⁽¹⁾
2	Lock portion material	B = Brass / S = Stainless steel
3	Mounting	P = Panel mount (back of board), standard
4	Contacts arrangement in normal position (key in)	C/O = NO/NC arrangement (contacts closed/open) CC = NC arrangement (all contacts closed)
5	Number of contacts	4, standard
6	Lock portion symbol	FS ⁽¹⁾ up to 3 characters / Q ⁽¹⁾ up to 6 characters

⁽¹⁾ Please see the Glossary on page 66-67 for more information

Please see our user manuals for more technical details and drawings, as well as mounting and maintenance information.

What our customers say

"Castell's interlocks have completely solved the problem. The trapped key system has worked really well and been welcomed by staff."

Mark Caulfield, Uniq Prepared Foods

K - Bolt Interlock

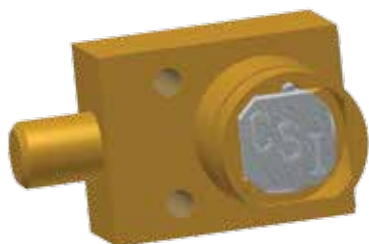

- Key operated mechanical bolt interlock
- Designed for the control of electrical switchgear
- Comes with a 15.88 mm diameter bolt available in various lengths
- Available with FS or Q type lock portions
- Manufactured in either brass or stainless steel
- Ideal for use in standard or harsh, corrosive environments
- Shear force of bolt: 30KN (stainless steel) and 19KN (brass)

K-FSB-6.4-4

Application

The K bolt interlocks are used as a part of a safety system to allow safe control of valves or disconnect switches.

While power supply to the system is switched on, the access doors to the hazardous area are locked closed. Key A is trapped in the disconnecter K bolt interlock (1) while the process is on. To enter the hazardous area, the disconnecter is turned to the OFF position and key A is released, locking the disconnecter in the disengaged position. Key A is then taken to the grounding switch. Key A enters the second K lock (2) which retracts the bolt enabling the cammed switch lever to be rotated to engage the ground. Once rotated, the recess in the cam aligns with the next K lock (3) with key B trapped in its lock. Key B can now be removed from K lock (3), which now locks the lever in place ensuring that the ground connection cannot be broken.

The system is now disconnected and grounded, key B can be taken to operate the access interlock on the door of the hazardous area to gain access into it.

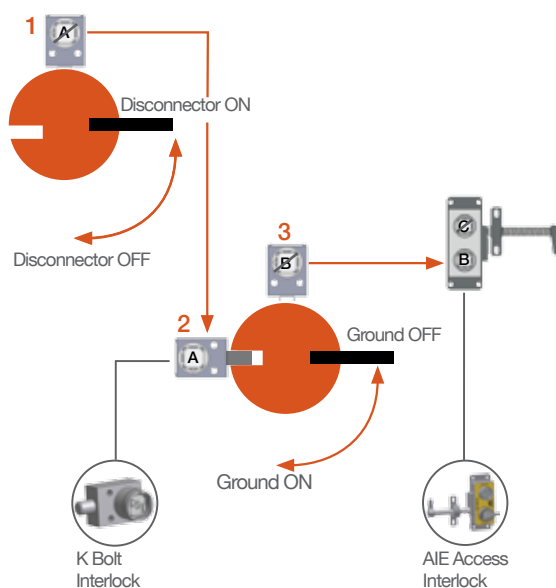

Order Information

	Product Type	1	2	3	4	5
Part Number	K					
Example	K	FS	B	6.4	4	TBA

1	Lock portion type	FS ⁽¹⁾ / Q ⁽¹⁾
2	Material	B = Brass / S = Stainless steel
3	L Dimension (bolt length when retracted) in mm	0 / 6,4 / 12,7 / 19,1 / 25,4
4	Form	1 / 2 / 3 / 4 ⁽¹⁾
5	Lock portion symbol	FS ⁽¹⁾ up to 3 characters / Q ⁽¹⁾ up to 6 characters

⁽¹⁾ Please see our glossary on pages 66-67 for more information

KL - Dual Key Bolt Interlock

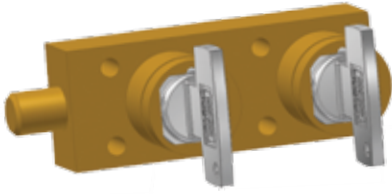

- Dual key bolt interlock is a key operated mechanical bolt interlock
- Designed for the control of electrical switchgear
- Comes with a 15,88 mm diameter bolt of variable lengths
- Available with FS or Q type lock portions
- Manufactured in either brass or stainless steel
- Ideal for use in standard or harsh, corrosive environments
- Available in a double key or exchange key condition
- Shear force of bolt: 30KN (stainless steel) and 19KN (brass)

KL-FSB-6.4-4-E

Application

KL dual key bolt interlocks are used as a part of a safety system. A typical application is where the electrical and pneumatic supplies to the machine are switched on and the access doors to the hazardous area are locked closed.

Keys A and B are trapped in the KL bolt interlock, preventing access to the machine area. To enter the area, the pneumatic supply must be turned off. Turning the keys in the KL bolt interlock will extend its bolt. The released keys ensure the bolt remains in extended position locking off the disconnecter.

The released keys can now be taken to the machine area to gain access via the AI access interlocks.

The disconnecter cannot be switched on until both access doors are locked closed and both keys replaced in the KL interlock.

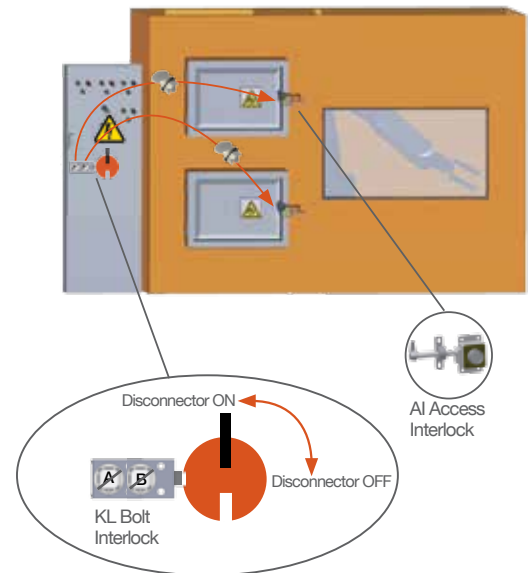

Order Information

	Product Type	1	2	3	4	5	6
Part Number	KL						
Example	KL	FS	B	6.4	4	E	TBA

1	Lock portion type	FS ⁽¹⁾ / Q ⁽¹⁾
2	Material	B = Brass / S = Stainless steel
3	L Dimension (bolt length when retracted) in mm	0 / 6,4 / 12,7 / 19,1 / 25,4
4	Form	1 / 2 / 3 / 4 ⁽¹⁾
5	Key Condition	D = Double key condition (both keys are free while bolt is extended) E = Exchange key condition (primary key is free while bolt is retracted, secondary key is trapped) ⁽²⁾
6	Lock portion symbol: Please advise for each lock as for primary and secondary locks ⁽²⁾ separately	FS ⁽¹⁾ up to 3 characters / Q ⁽¹⁾ up to 6 characters

⁽¹⁾ Please see our glossary on pages 66-67 for more information

⁽²⁾ Primary key/lock is located next to the bolt

More lock portions available upon special enquiry

KF - Bolt Interlock with Flange

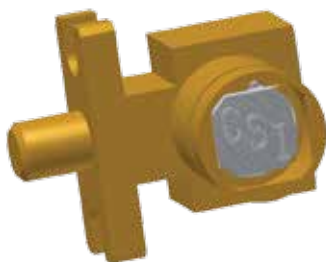

- Key operated mechanical bolt interlock
- Designed for the control of electrical switchgear
- The standard unit comes with a 15.88 mm diameter bolt of variable length
- Equipped with a flange to allow for different sorts of mounting
- Available with FS or Q type lock portions
- Manufactured in either brass or stainless steel
- Ideal for use in standard or harsh, corrosive environments
- Shear force of bolt: 30KN (stainless steel) and 19KN (brass)

KF-FSB-6.4-4

Application

The KF bolt interlocks are used as a part of a safety system to allow safe control of valves or disconnect switches.

While power supply to the system is switched on, the access doors to the hazardous area are locked closed. Key A is trapped in the disconnecter KF bolt interlock (1) while the process is on. To enter the hazardous area, the disconnecter is turned to the OFF position and key A is released, locking the disconnecter in the disengaged position. Key A is then taken to the grounding switch. Key A enters the second KF lock (2) which retracts the bolt enabling the cammed switch lever to be rotated to engage the ground. Once rotated, the recess in the cam aligns with the next KF lock (3) with key B trapped in its lock. Key B can now be removed from KF lock (3), which now locks the lever in place ensuring that the ground connection cannot be broken.

The system is now disconnected and grounded, key B can be taken to operate the access interlock on the door of the hazardous area to gain access into it.

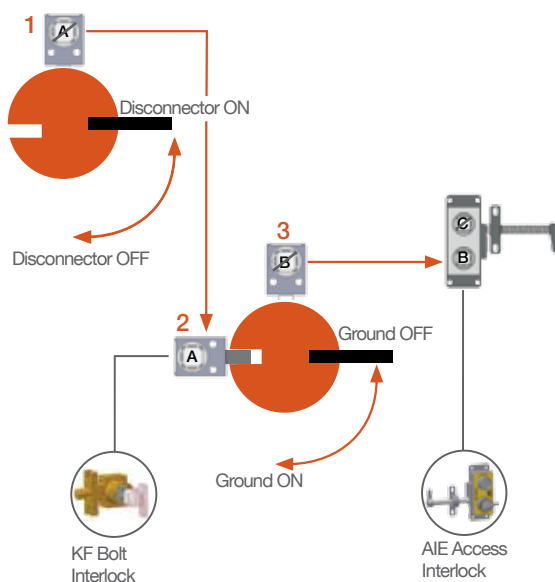

Order Information

	Product Type	1	2	3	4	5
Part Number	KF					
Example	KF	FS	B	6.4	4	TBA

1	Lock portion type	FS ⁽¹⁾ / Q ⁽¹⁾
2	Material	B = Brass / S = Stainless steel
3	L Dimension (bolt length when retracted) in mm	0 / 6,4 / 12,7 / 19,1 / 25,4
4	Form	1 / 2 / 3 / 4 ⁽¹⁾
5	Lock portion symbol	FS ⁽¹⁾ up to 3 characters / Q ⁽¹⁾ up to 6 characters

⁽¹⁾ Please see our glossary on pages 66-67 for more information

KLF - Dual Key Bolt Interlock with Flange

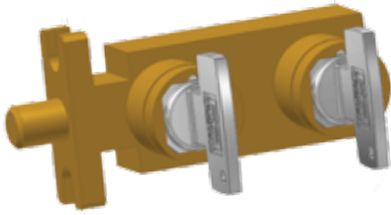

- Key operated mechanical bolt interlock
- Designed for the control of electrical switchgear
- Comes with a 15,88 mm diameter bolt of variable lengths
- Equipped with a flange to allow for different sorts of mounting
- Available with FS or Q type lock portions
- Manufactured in either brass or stainless steel
- Ideal for use in standard or harsh, corrosive environments
- Available in a double key or exchange key condition
- Shear force of bolt: 30KN (stainless steel) and 19KN (brass)

KLF-FSB-6.4-4-E

Application

KLF dual key bolt interlocks are used as a part of a safety system. A typical application is where the electrical and pneumatic supplies to the machine are switched on and the access doors to the hazardous area are locked closed.

Key A and B are trapped in the KLF bolt interlock, preventing access to the machine area. To enter the area, the pneumatic supply must be turned off. Turning the keys in the KLF bolt interlock will extend its bolt. The released keys ensure the bolt remains in extended position locking off the disconnecter. The released keys can now be taken to the machine area to gain access via the AI access interlocks.

The disconnecter cannot be switched on until both access doors are locked closed and both keys replaced in the KLF interlock.

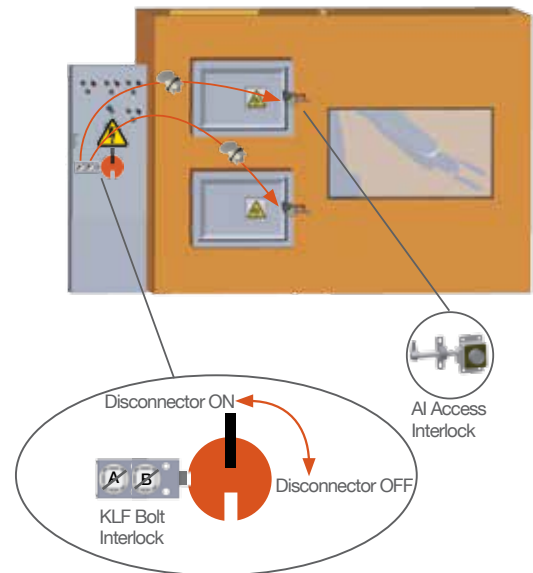

Order Information

	Product Type	1	2	3	4	5	6
Part Number	KLF						
Example	KLF	FS	B	6.4	4	E	TBA

1	Lock portion type	FS ⁽¹⁾ / Q ⁽¹⁾
2	Material	B = Brass / S = Stainless steel
3	L Dimension (bolt length when retracted) in mm	0 / 6,4 / 12,7 / 19,1 / 25,4
4	Form	1 / 2 / 3 / 4 ⁽¹⁾
5	Key Condition	D = Double key condition (both keys are free while bolt is extended) E = Exchange key condition (primary key is free while bolt is retracted, secondary key is trapped) ⁽²⁾
6	Lock portion symbol: Please advise for each lock as for primary and secondary locks ⁽²⁾ separately	FS ⁽¹⁾ up to 3 characters / Q ⁽¹⁾ up to 6 characters

⁽¹⁾ Please see our glossary on pages 66-67 for more information

⁽²⁾ Primary key/lock is located next to the bolt

More lock portions available upon special enquiry

Mechanical Isolation

KC - Claw Interlock

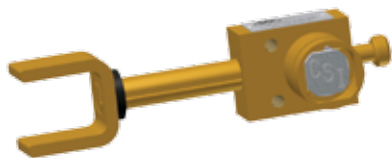

- Key operated mechanical bolt interlock
- Designed for the control of electrical switchgear
- Standard unit comes with a 15.88 mm diameter bolt fitted with a claw
- Variable bolt length and claw dimensions to suit particular requirements
- Available with FS or Q type lock portions
- Manufactured in either brass or stainless steel
- Ideal for use in standard or harsh, corrosive environments

KC-FSB-4-19.1-55-28.9

Application

The KC claw interlock is used as a part of a safety system, typically in machine guarding applications. It is usually used in combination with an access interlock such as the Salus for part body access or an access interlock with an exchange key for full body access control such as AIE.

While the power supply is switched on, the key is trapped in the KC claw interlock. To lock off the power supply switch, manually drive the bolt to extended position. This will release the key keeping the bolt extended and the switch locked off. The key is released and taken by the personnel to unlock the AI access interlock on the access door. While the access door is opened, the key remains trapped in the AI lock.

The system has to be designed so that the bolt of the KC claw interlock cannot be retracted to unlock the power supply until the door to the machine is locked, the key removed from AI access lock and the replaced into the KL claw interlock.

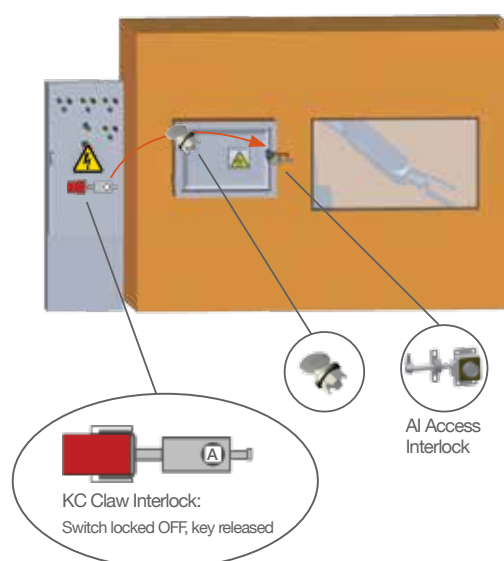

Order Information

	Product Type	1	2	3	4	5	6	7
Part Number	KC							
Example	KC	FS	B	4	19.1	55	28.9	TBA

1	Lock portion type	FS ⁽¹⁾ / Q ⁽¹⁾
2	Material	B = Brass / S = Stainless steel
3	Form	1 / 2 / 3 / 4 ⁽¹⁾
4	A dimension (bolt travel) ⁽²⁾	Please specify: 57mm - 127mm (in mm), to be minimum 30mm greater than B dimension
5	B dimension ⁽²⁾	Please specify (in mm)
6	D dimension ⁽²⁾	Please specify (in mm)
7	Lock portion symbol	FS ⁽¹⁾ up to 3 characters / Q ⁽¹⁾ up to 6 characters

⁽¹⁾ Please see our glossary on pages 66-67 for more information

⁽²⁾ Please refer to our user manuals for claw details

KLC - Dual Key Claw Interlock

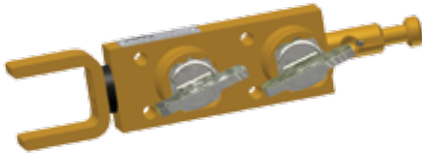

- Dual-key operated mechanical bolt interlock
- Designed for the control of electrical switchgear
- Comes with a 15,88 mm diameter bolt fitted with a claw
- Available with FS or Q type lock portions
- Manufactured in either brass or stainless steel
- Ideal for use in standard or harsh, corrosive environments
- Available in a double key or exchange key condition

KLC-FSB-4-E-19.1-55-28.9

Application

The KLC claw interlock is used as a part of a safety system, typically in machine guarding applications. It is usually used in combination with an Access Interlock such as the Salus for part body access or an Access Interlock with an exchange key for full body access control such as AIE.

While the power supply is switched on, both keys are trapped in the KLC claw interlock. To lock off the power supply switch, drive the bolt to extended position. The design has to be such that the bolt cannot be extended when the system is turned on. This will release the keys keeping the bolt extended and the switch locked off. The released keys are taken by the personnel to unlock the AI access interlocks on the access doors. While the access doors are opened, the keys remain trapped in the AI locks.

The bolt of the KLC claw interlock cannot be retracted to unlock the power supply until both doors to the machine are locked, keys removed from AI access interlocks and the replaced into the KLC claw interlock.

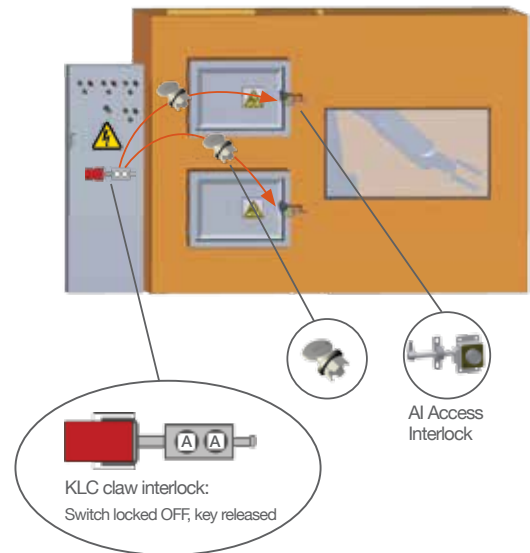

Order Information

	Product Type	1	2	3	4	5	6	7	8
Part Number	KLC								
Example	KLC	FS	B	4	4	19.1	55	28.9	TBA

1	Lock portion type	FS ⁽¹⁾ / Q ⁽¹⁾
2	Material	B = Brass / S = Stainless steel
3	Form	1 / 2 / 3 / 4 ⁽¹⁾
4	Key Condition	D = Double key condition (both keys are trapped or free) E = Exchange key condition (primary key is free while bolt/claw is retracted, secondary key is trapped) ⁽²⁾
5	A dimension (bolt travel) ⁽³⁾	Please specify: 57mm - 127mm (in mm), to be minimum 30mm greater than B dimension
6	B dimension ⁽³⁾	Please specify (in mm)
7	D dimension ⁽³⁾	Please specify (in mm)
8	Lock portion symbol: Please advise for each lock as for primary and secondary ⁽²⁾ locks separately	FS ⁽¹⁾ up to 3 characters / Q ⁽¹⁾ up to 6 characters

⁽¹⁾ Please see our glossary on pages 66-67 for more information

⁽²⁾ Primary key/lock is located next to the bolt/claw

⁽³⁾ Please refer to our user manuals for claw details

More lock portions available upon special enquiry

Please see our user manuals for more technical details and drawings, as well as mounting and maintenance information.

Mechanical Isolation

KP - Bolt Interlock with Safety Switch



- Key operated mechanical bolt interlock
- Complete with position monitoring electrical contacts
- Designed for the control of electrical switchgear or valves
- Comes with a 15,88 mm diameter bolt of variable lengths
- Comes with 2N/C 1N/O 10 A contacts (KP1) or with 4N/C 2N/O 10 A contacts (KP2)
- Available with FS or Q type lock portions
- Manufactured in either brass or stainless steel
- Ideal for use in standard or harsh, corrosive environments
- Shear force of bolt: 30KN (stainless steel) and 19KN (brass)

KP1-FSB-6.4-FR-4

Application

KP bolt interlocks with safety switches are used as a part of a safety system, typically in switchgear applications.

The electrical supply of the machine is on, and the protective door to the hazardous area is locked. The key is trapped in the KP bolt interlock. Before entering the machine area the disconnecter lever needs to be rotated to isolate the machine. To lock the disconnecter lever in the safe position the key in the KP bolt interlock needs to be turned extending the bolt of the KP. Removing the key traps the bolt in the extended position. The operation of the KP also changes the contacts in the KP switch. This is connected to a traffic light or another display, indicating the access to machine area can be gained.

The removed key is taken to the AI access interlock to open the door. The power supply cannot be switched back on while the key is trapped in the access interlock.

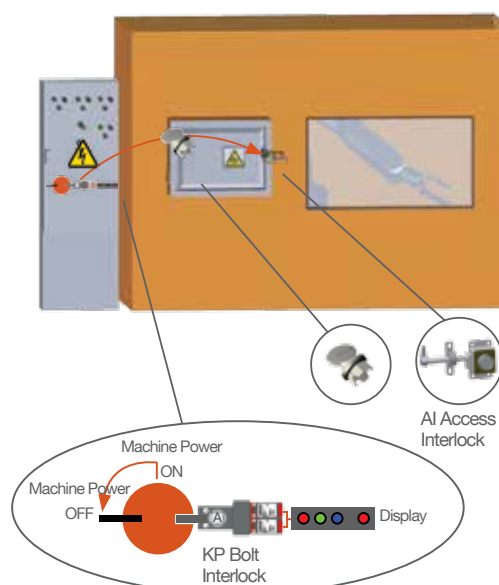

Order Information

	Product Type	1	2	3	4	5	6	7
Part Number	KP							
Example	KP	1	FS	B	6.4	FR	4	TBA

1	Switch specification	1 = 2NC/1NO 2 = 4NC/2NO
2	Lock portion type	FS ⁽¹⁾ / Q ⁽¹⁾
3	Material	B = Brass / S = Stainless steel
4	L Dimension (bolt length when retracted) in mm	0 / 6,4 / 12,7 / 19,1 / 25,4 ⁽¹⁾
5	Switch entry	RE = Rear entry / FR = Front entry ⁽¹⁾
6	Form	1 / 2 / 3 / 4 ⁽¹⁾
7	Lock portion symbol	FS ⁽¹⁾ up to 3 characters / Q ⁽¹⁾ up to 6 characters

⁽¹⁾ Please see our glossary on pages 66-67 for more information

Please see our user manuals for more technical details and drawings, as well as mounting and maintenance information.

KLP - Multi-key Bolt Interlock with Safety Switch

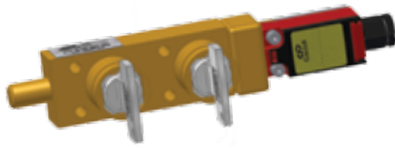

KLP1-FSB-1S-0-FR-4-E

- Key operated mechanical bolt interlock
- Complete with position monitoring electrical contacts
- Designed for the control of electrical switchgear or valves
- Comes with a 15,88 mm diameter bolt of variable lengths
- Comes with 2N/C 1N/O 10 A contacts (KP1) or 4N/C 2N/O 10 A contacts (KP2)
- Available with FS or Q type lock portions
- Manufactured in either brass or stainless steel
- Ideal for use in standard or harsh, corrosive environments
- Available in a double key or exchange key condition
- Shear force of bolt: 30KN (stainless steel) and 19KN (brass)

Application

KLP bolt interlocks with safety switches are used as a part of a safety system, typically in switchgear applications.

The electrical supply of the machine is on, and the protective doors to the hazardous area are locked. Both keys are trapped in the KLP unit. Before entering the machine area the disconnecter lever needs to be rotated to isolate the power to the machine. To lock the disconnecter lever in the safe position both keys in the KLP bolt interlock need to be released. This extends the bolt of the KLP, locks it in the extended position and changes the contacts in the KLP switch. This is connected to a traffic light or another display, indicating the access to machine area can be gained.

The removed keys are taken to the AI access interlocks to open the doors. The power supply cannot be switched back on while the keys are trapped in the access interlocks.

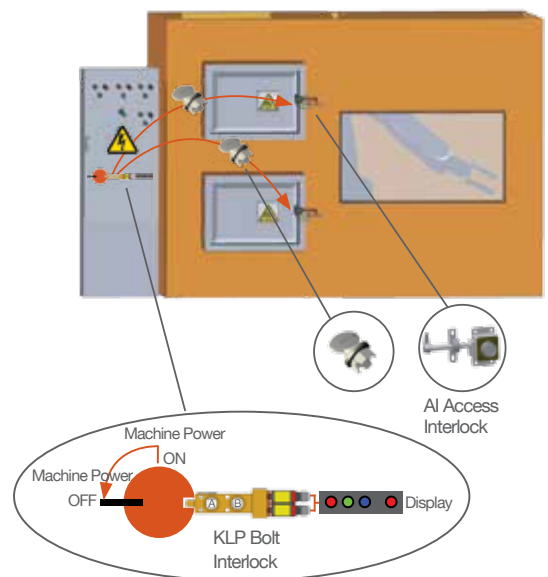

Order Information

	Product Type	1	2	3	4	5	6	7	8	9
Part Number	KLP									
Example	KLP	1	FS	B	1S	0	FR	4	E	TBA

1	Switch specification	1 = 2NC/1NO (1 switch) 2 = 4NC/2NO (2 switches)
2	Lock portion type	FS ⁽¹⁾ / Q ⁽¹⁾
3	Material	B = Brass / S = Stainless steel
4	Secondary lock portion(s)	1S / 2S / 3S = 1 / 2 or 3 secondary lock portions respectively
5	L Dimension (bolt length when retracted) in mm	0 / 6,4 / 12,7 / 19,1 / 25,4 ⁽¹⁾
6	Switch entry	RE = Rear entry / FR = Front entry ⁽¹⁾
7	Form	1 / 2 / 3 / 4 ⁽¹⁾
8	Key Condition	D = Double key condition (both keys are trapped or free) E = Exchange key condition (primary key is free while bolt is retracted, secondary key is trapped) ⁽²⁾
9	Lock portion symbol: Please advise for each lock as for primary and secondary ⁽²⁾ locks separately	FS ⁽¹⁾ up to 3 characters / Q ⁽¹⁾ up to 6 characters

⁽¹⁾ Please see our glossary on pages 66-67 for more information

⁽²⁾ Primary key/lock is located next to the bolt

Please see our user manuals for more technical details and drawings, as well as mounting and maintenance information.

Mechanical Isolation



FS-1B-ACW-45-9.5-22

FS / Q - Switchgear Interlock

- Switchgear interlock
- Designed for use as a mechanical interlock for electrical switchgear through a mechanical connection to the isolation equipment
- Fitted with a 9.5mm square x 22mm length spigot that can be used to operate an isolator
- Spigot movement ensured by key rotation in a pre-determined angular position (45°/65°/90° clockwise or anti-clockwise) closes the isolator
- Available with FS or Q type lock portions
- Manufactured in either brass or stainless steel
- Ideal for use in standard or harsh, corrosive environments

Application

The FS/Q locks are used to ensure that multiple supplies are not applied to common bus bars. When all incomers are closed the bus bars are open. To close a bus bar, first the incomers must be switched to open.

In the shown is application to close Bus 1, either incomer AA or AB must be opened. The key is removed from either AA or AB connection and is then inserted into the bus switch A₋ (A BLANK). To close Bus 2, either incomer AB or BB must be opened and the key AB or BB transferred to the switch B₋ (BLANK B).

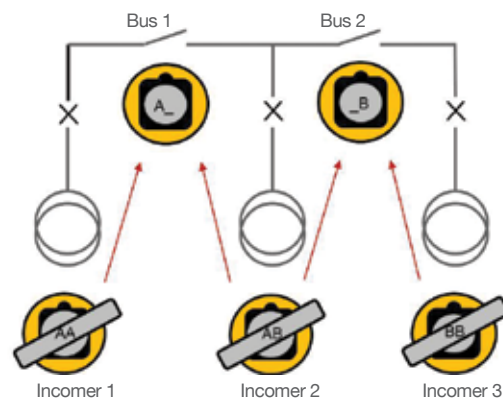

Order Information

	Product Type	1	2	3	4	5	6	7	8
Part Number	FS / Q								
Example	FS	1	B	ACW	45	9.5	22	TBA	

1	Lock portion type	FS ⁽¹⁾ / Q ⁽¹⁾
2	Mounting position	1 = 45° clockwise / 2 = 45° anti-clockwise ⁽¹⁾
3	Material	B = Brass / S = Stainless steel / PL = Nickel plated
4	Rotational movement	CW = Clock wise / ACW = Anti-clockwise ⁽¹⁾
5	Key rotation (degree movement)	45° / 65° / 90° ⁽¹⁾
6	Spigot square profile	9,5 = 9,5 x 9,5 mm, standard
7	Spigot length	22 = 22 mm, standard
8	Lock portion symbol	FS ⁽¹⁾ up to 3 characters / Q ⁽¹⁾ up to 6 characters

⁽¹⁾ Please see our glossary on pages 66-67 for more information

Please see our user manuals for more technical details and drawings, as well as mounting and maintenance information.

What our customers say

"In our experience, when the alignment of a door or hatch is not stable, it is better not to use normal safety switches for isolation of protected units. For these types of applications we usually would recommend to our customers systems using a separate isolation unit and AI/AIE locks for the misaligned doors or hatches."

Tony Tarr, OEM Automatic, Finland

Time Delay Interlocking



DAE - Mechanical Time Delay Unit

- DAE - delayed access exchange
- Key controlled mechanical time delay interlock
- Designed to control access to dangerous machines with a run-down time or where machinery must complete an operating cycle before access is permitted
- Made for applications where the availability of the main power is limited or where the timer needs to be located in a potentially explosive atmosphere
- Mild steel enclosure
- Available with FS or Q type lock portions

DAE-FSB-30

Application

In a typical application, the DAE mechanical time delay unit is designed to operate as a part of an integrated safety system that controls access to hazardous areas.

The release of the isolation key (key A) from a key switch, e. g. KS, interrupts the electrical supply to the machine. Key A is then placed in the DAE time delay unit and turned, initiating the timer. After completion of the time out period another key (key B) can be released (the time delay must be longer than the machine run-down time).

Key B can then be taken to the AIE access interlock and the door to the machine room can be opened.

The machine cannot be restarted until the door is locked closed and the key is returned to the DAE.

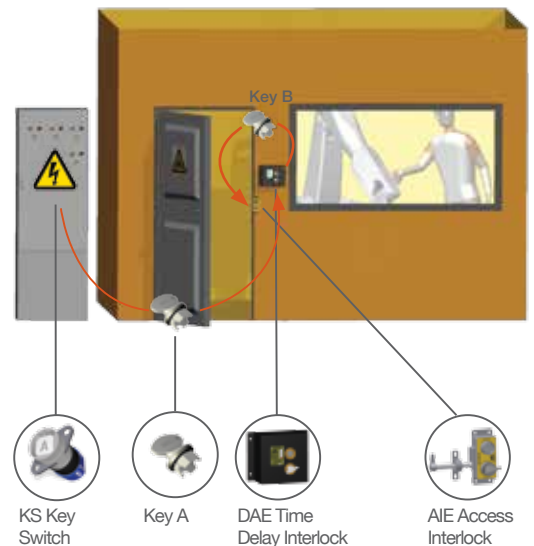

Order Information

	Product Type	1	2	3	4
Part Number	DAE	-		-	
Example	DAE	-	FS	-	30 TBA

1	Lock portion type	FS ⁽¹⁾ / Q ⁽¹⁾
2	Lock portion material	B = Brass, standard
3	Time delay	30 / 60 or 90 sec, standard or as required (max. 30min)
4	Lock portion symbol	FS ⁽¹⁾ up to 3 digits / Q ⁽¹⁾ up to 6 digits

⁽¹⁾ Please see our glossary on pages 66-67 for more information

Please see our user manuals for more technical details and drawings, as well as mounting and maintenance information.

TDI - Electronic Time Delay Isolator



- Electronic time delay isolator and a heavy duty trapped key interlock switch
- Controlled by a fail-safe timer and solenoid
- Designed to control access to hazardous machines with run down times
- Can be used in high risk applications
- Incorporates a dual channel fail-safe timer, a heavy duty continuously rated solenoid, solenoid position monitoring, a 20 A isolation switch, a front panel lamp indication of solenoid position and a timer failure
- Available with FS or Q type lock portions
- One or more lock portions for multiple access applications available

TDI-FSB-F-N/O6-110A

Application

The TDI is designed to operate as part of an integrated safety system, controlling access to hazardous areas to motor driven, high risk applications, where a certain rundown time is required before access is granted.

When the machine is running, the key of the TDI interlock cannot be removed, preventing access to the hazardous area. To gain access to the machinery, the electrical supply must be switched off by turning the switch unit to OFF position. When the machine stop sequence is initiated, a signal from the machine control circuits starts the internal timer. After a pre-set time (which must exceed the machine run down time), the timer energises the solenoid illuminating the green LED. By pushing the green button the key can be released from the TDI unit. This key is taken by the personnel to the AIE access interlock.

The machine cannot be restarted until the door is locked closed and the key is returned to the TDI.

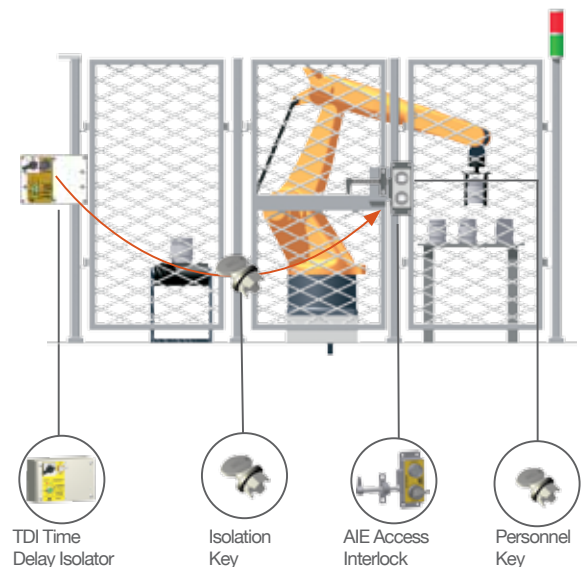

Order Information

	Product Type	1	2	3	4*	5*	6	7	8	9	10
Part Number	TDI										
Example	TDI	FS	B	F	-	-	N/O	6	110	A	TBA

1	Lock portion type	FS ⁽¹⁾ / Q ⁽¹⁾
2	Material	B = Brass / S = Stainless steel
3	Mounting	F = Front of board mount, with enclosure P = Panel mount
4*	Optional: Secondary lock portion(s)	1 / 2 / 3 or more secondary lock portions available
5*	Refers to item 4: Key condition	S = Secondary lock portions, if sequential removal of all keys required E = Secondary lock portions, if exchange key condition required ⁽¹⁾
6	Contacts arrangement in normal position	N/O = NO/NC arrangement (contacts closed/open)
7	Contacts number	6, standard
8	Control voltage	110 / 24 / 240, standard
9	Current	VAC / VDC
10	Lock portion symbol: Please advise for each lock separately as for isolation key/lock and personnel key/lock	FS ⁽¹⁾ up to 3 characters / Q ⁽¹⁾ up to 6 characters

⁽¹⁾ Please see our glossary on pages 66-67 for more information

Please see our user manuals for more technical details and drawings, as well as mounting and maintenance information.

Time Delay Interlocking

TDR - Time Delay Remote Unit with Electrical Isolation



- Time delay remote unit and heavy duty trapped key interlock
- Switch controlled by a fail-safe timer and solenoid
- Designed to control access to hazardous machines with run down times
- Can be used in high risk applications
- Incorporates a dual channel fail-safe timer, heavy duty continuously rated solenoid, solenoid position monitoring, 20 A electrical switch, front panel lamp indication of solenoid position and timer failure with up to four locks for multiple access applications
- Available with FS or Q type lock portions

TDR-FSB-F-N/O6-110A

Application

The TDR is designed to operate as part of an integrated safety system, controlling access to hazardous areas to motor driven high risk applications where a certain time rundown is required before access is granted.

While machine is running, the key is trapped in the TDR interlock, preventing access to the machine area. To gain access to the area, the electrical supply must be switched off via the machine control panel. When the machine stop sequence is initiated, a signal from the machine control circuit starts the internal timer. After a pre-set time (which must exceed the machine run down time), the timer energises the solenoid illuminating the green LED. By pushing the green button the key can be released. This isolation key is taken to the AIE access interlock to open the door. A second key (personnel key) can be released from the AIE and taken by personnel into the machine area.

The machine cannot be restarted until the door is locked closed and the isolation key returned to the TDR.

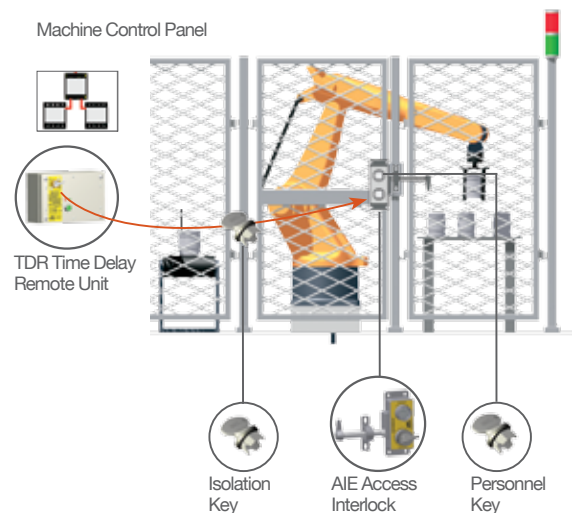

Order Information

	Product Type	1	2	3	4*	5*	6	7	8	9	10
Part Number	TDR										
Example	TDR	FS	B	F	-	-	N/O	6	110	A	TBA

1	Lock portion type	FS ⁽¹⁾ / Q ⁽¹⁾
2	Material	B = Brass / S = Stainless steel
3	Mounting	F = Front of board mount with enclosure, standard
4*	Optional: Secondary lock portion(s)	1, standard
5*	Refers to item 4: Key condition	D = Double key version S = Secondary keys as for exchange key version
6	Contacts arrangement in normal position	N/O = NO/NC arrangement (contacts closed/open)
7	Number of contacts	6, standard
8	Control voltage	110 / 24 / 240, standard
9	Current	VAC / VDC
10	Lock portion symbol: Please advise for each lock separately!	FS ⁽¹⁾ up to 3 characters / Q ⁽¹⁾ up to 6 characters

⁽¹⁾ Please see our glossary on pages 66-67 for more information

Please see our user manuals for more technical details and drawings, as well as mounting and maintenance information.



What our customers say

“With the timber industry prevailing in Sweden, Castell systems for saw mill applications are of upmost importance. Machines such as band saws which have a danger of moving blades require a safe electrical isolation to then gain full body access. Castell systems ensure that access can only be gained once the hazardous area is safe and with the personnel key on access interlocks the system provides extra safety to the personnel working on the band saw.”

Niclas Fritz, OEM Automatic AB, Sweden



Motion Sensing



BEMF-FSB-F-3-110A

BEMF - Motor Sensing Interlock

- Motor sensing interlock
- Designed to control access to rotating machinery
- Relies on the measurement of the electromotive force generated by the windings of an electric motor
- Only when the motor has stopped will the BEMF drop to zero and allow the release of a key
- The unit is used for connection to AC and DC motors including DC braking systems
- Designed to provide the highest level of safety when installed as part of an access control system for dangerous machinery
- Available with FS or Q type lock portions

Application

The BEMF is designed to operate as part of an integrated safety system. The BEMF controls access to hazardous areas with rotating machinery.

When the electric motor is running, the key of the BEMF interlock cannot be removed, hence preventing access to the hazardous area. To gain access to the area, the electrical motor must be switched off by turning the key to OFF position. This changes the switches of the electrical supply to the machine to a safe condition. Only when the motor has stopped will the BEMF drop to zero and allow the release of a key. A green LED illuminates. By pushing the green button, the key can now be removed and taken by the personnel to the AI access interlock.

The guard can only be opened when the electrical supply has been switched into a safe condition. The machine cannot be restarted until the door is closed and the key is removed and taken to the BEMF.

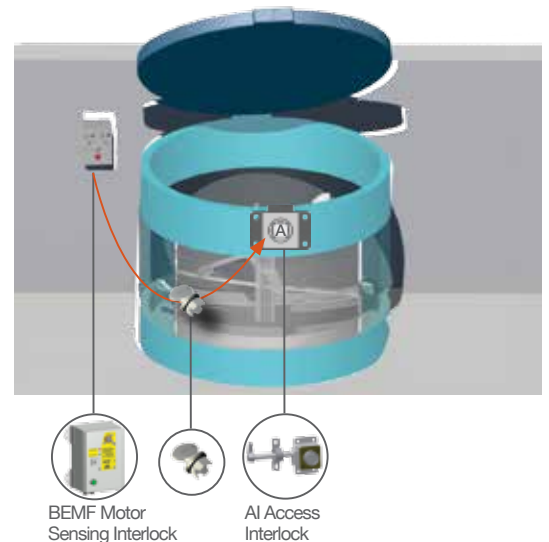

Order Information

	Product Type	1	2	3	4	5	6	7
Part Number	BEMF							
Example	BEMF	FS	B	F	3	110	A	TBA

1	Lock portion type	FS ⁽¹⁾ / Q ⁽¹⁾
2	Material	B = Brass, standard
3	Mounting	F = Front of board mount with enclosure, standard
4	Number of poles	3, standard
5	Voltage	24 / 110 / 240, standard
6	Current	AC (use for 110V and 240V) / DC (use for 24V)
7	Lock portion symbol	FS ⁽¹⁾ up to 3 characters / Q ⁽¹⁾ up to 6 characters

⁽¹⁾ Please see our glossary on pages 66-67 for more information

More lock portions available upon special enquiry



MSI-FSB-F-3-110A

MSI - Motion Sensing Interlock

- Motion sensing interlock
- Designed to control access to rotating machinery that has a run-down time
- Relies on the detection of motion via two sensors
- Only when both sensors detect zero movement can the key be released
- Designed to provide the highest level of safety when installed as part of an access control system for dangerous machinery
- Available with FS or Q type lock portions

Application

The MSI is designed to operate as part of an integrated safety system, controlling access to hazardous areas to motor driven, high risk applications where complete isolation of the power supply is required before access is granted.

Two sensors are positioned on the rotating shaft, these are wired into the MSI unit. When the electric motor is running, the key of the MSI interlock cannot be removed, hence preventing access to the hazardous area. To gain access to the area, the electrical motor must be switched off by turning the key to OFF position. This changes the switches of the electrical supply to the machine to a safe condition. A movement sensing detector sends a signal to the MSI unit once a zero movement of the motor has been stated. A green LED illuminates. By pushing the green button, the key can now be removed and taken by the personnel to the AI access interlock.

The guard can only be opened when the electrical supply has been switched into a safe condition. The machine cannot be restarted until the door is closed and the key is removed and taken to the MSI.

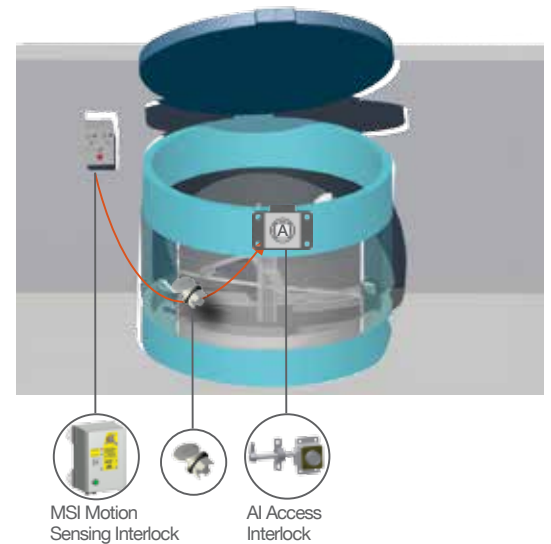

Order Information

	Product Type	1	2	3	4	5	6	7
Part Number	MSI							
Example	MSI	FS	B	F	3	110	A	TBA

1	Lock portion type	FS ⁽¹⁾ / Q ⁽¹⁾
2	Material	B = Brass, standard
3	Mounting	F = Front of board mount with enclosure, standard
4	Number of poles	3, standard
5	Control voltage	110 / 24 / 240, standard
6	Current	AC (use for 110V and 240V) / DC (use for 24V)
7	Lock portion symbol	FS ⁽¹⁾ up to 3 characters / Q ⁽¹⁾ up to 6 characters

⁽¹⁾ Please see our glossary on pages 66-67 for more information

More lock portions available upon special enquiry

Valve Interlocking



MBV-FSS-L/O-L/C

MBV - Modular Ball Valve Interlock

- Integral valve interlock designed to enable the locking off, in either the open, closed or both open and closed conditions
- Suitable for any quarter-turn valves including ball, plug and butterfly valves up to 2 1/2" bore size
- Fitting enforces a logical, pre-determined and safe sequence of operation where the control of flow paths is critical
- Available with FS or Q type lock portions
- Manufactured in stainless steel with stainless steel lock portions
- Ideal for use in standard or harsh, corrosive environments

Application

The MBV is designed to operate as part of an integrated safety system controlling the operation of quarter turn ball valves in safety critical applications. The typical application of the MBV modular ball valves interlocks is preventing unauthorised closing of one of the lines ensuring that one line is always open.

Interlock valves in both open and closed positions have an inter-changeable key between the valves ensuring that the first valve is closed before the second is open. While the operational line is locked open, the service line is locked closed. Prior to opening the service line it needs to be ensured the operational line is locked closed. By inserting key A (from control room) in the MBV, which controls the operational line, you can unlock the valve and bring it from open to closed. By turning and releasing key B, you can lock the valve in the closed condition.

Key B can be taken to the next valve, which controls the service line. This valve can now be unlocked by inserting and turning key B in the MBV. The valve position can then be changed from closed to open and locked in the open position by releasing key C. This key can then be taken to the control room.

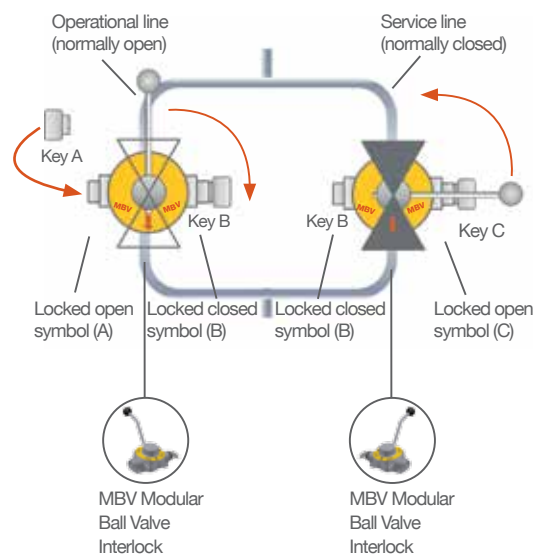

Order Information

	Product Type	1	2	3	4*	5
Part Number	MBV					
Example	MBV	FS	S	L/O - L/C		TBA

1	Lock portion type	FS ⁽¹⁾ / Q ⁽¹⁾
2	Material	S = Stainless steel, standard
3	Valve locked state	L/O = locked open ⁽¹⁾ L/C = locked closed ⁽¹⁾ L/O-L/C = locked open and closed ⁽¹⁾
4*	Optional: Switch options available	SWITCH = complete with LIMIT SWITCH EEXDSW = complete with ATEX LIMIT SWITCH
5	Lock portion symbol(s): Please advise for each lock separately as L/O Symbol = locked open symbol ⁽¹⁾ L/C Symbol = locked closed symbol ⁽¹⁾	FS ⁽¹⁾ up to 3 characters / Q ⁽¹⁾ up to 6 characters

⁽¹⁾ Please see our glossary on pages 66-67 for more information

Please see our user manuals for more technical details and drawings, as well as mounting and maintenance information.

What our customers say

"The Castell interlocking systems are fitted with great satisfaction on our CO₂ plants around Italy and the interlocking operations fit perfectly our requirements. We are fully satisfied with Castell interlocks, as they ensure our operation maintenance safety at 100%."

Federico Sgambati, Eusebi Impianti, Italy



The use of key exchange boxes forms part of the integrated solution to safety in machinery and switchgear applications.

In complex operations a number of isolations and/or multiple access points may need to occur to ensure that protected areas are safe to work on.

The exchange boxes enable both multiple isolations as well as multiple access through the transfer of keys.

Key Exchange

Key Exchange Boxes

40



Key Exchange Boxes

X - Key Exchange Box



- Key exchange box
- Designed to enable a sequential release of keys by insertion of an initial key
- The need for this type of product usually arises when there are multiple points of entry
- Designed to be the link between the isolation units and access interlocks
- Available in a number of configurations and number of locks
- Supplied in an enclosure suitable for surface mounting
- Available with FS or Q type lock portions

X-FSB-H-1/3

Application

A typical application of the X key exchange box is machine guarding with one or more access points to the hazardous area. The key exchange box is used as a part of a safety system, which ensures a machine is shut down, before access to the hazardous area is allowed.

The system involves a KS key switch for the electrical supply and typically more than one AIE access interlocks for full body access. The removal of the isolation key from the key switch isolates the electrical supply to the machine. This key is taken to the X key exchange box to release the trapped keys. The sequentially released keys are used to gain access through the AIE door interlocks.

The machine cannot be restarted until all keys are returned to the key exchange box and the power isolation key is removed and taken to the KS.

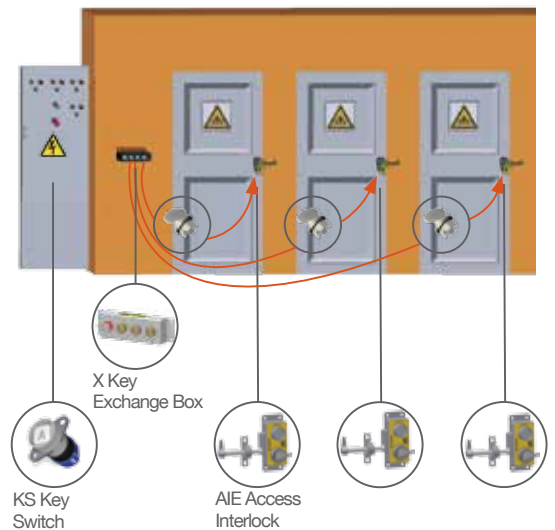

Order Information

	Product Type	1	2	3	4	5	6
Part Number	X						
Example	X	FS	B	H	1	3	TBA

1	Lock portion type	FS ⁽¹⁾ / Q ⁽¹⁾
2	Material	B = Brass S = Stainless steel
3	Mounting	H = Horizontal V = Vertical
4	Number of free keys (keys in)	Please specify ⁽¹⁾
5	Number of trapped keys (keys out)	Please specify ⁽¹⁾
6	Lock portion symbols: Please advise each lock separately as free key symbols (keys in) and trapped key symbols (keys out)	FS ⁽¹⁾ up to 3 characters / Q ⁽¹⁾ up to 6 characters

⁽¹⁾ Please see our glossary on pages 66-67 for more information

Please see our user manuals for more technical details and drawings, as well as mounting and maintenance information.

B - Key Exchange Box

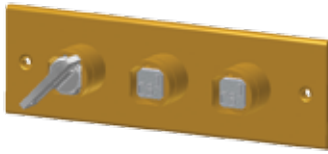

- Key exchange box
- Designed to enable a sequential release of keys, by insertion of an initial key
- Made for usage in situation where multiple access points to the hazardous area are given
- Designed to be the link between the isolation units and access interlocks
- Available in different configurations of locks, up to 7 locks maximum
- Suitable for surface or panel mounting
- Available with FS or Q type lock portions

B-FSB-H-1/2

Application

A typical application of the B key exchange box is machine guarding with one or more access points to the hazardous area. The B key exchange box is used as a part of a safety system, which ensures a machine is shut down, before access to the hazardous area is allowed.

The system involves a KS key switch for the electrical supply and typically more than one AIE access interlocks for full body access. The removal of the isolation key from the key switch isolates the electrical supply to the machine. This key is taken to the B key exchange box to release the trapped keys. The released keys are used to gain access through the AIE door interlocks.

The machine cannot be restarted until all keys are returned to the key exchange box and the power isolation key is removed and replaced in the KS.

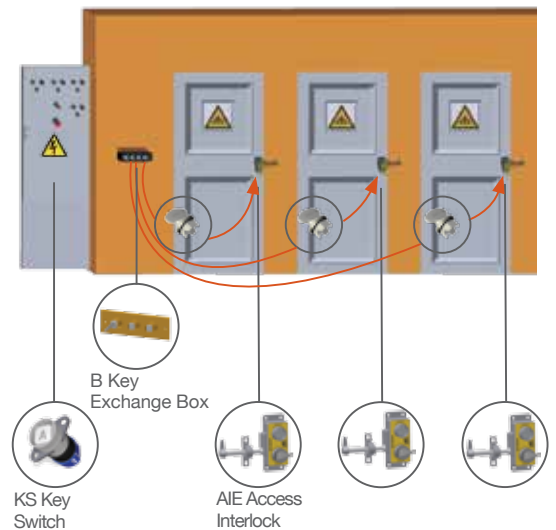

Order Information

	Product Type	1	2	3	4	5	6
Part Number	B						
Example	B	FS	B	H	1	2	TBA

1	Lock portion type	FS ⁽¹⁾ / Q ⁽¹⁾
2	Material	B = Brass, standard
3	Mounting	H = Horizontal V = Vertical
4	Number of free keys (keys in)	Please specify ⁽¹⁾
5	Number of trapped keys (keys out)	Please specify ⁽¹⁾
6	Lock portion symbol(s): Please advise each lock separately as free key symbols (keys in) and trapped key symbols (keys out)	FS ⁽¹⁾ up to 3 characters / Q ⁽¹⁾ up to 6 characters

⁽¹⁾ Please see our glossary on pages 66-67 for more information

Please see our user manuals for more technical details and drawings, as well as mounting and maintenance information.

Key Exchange Boxes

Z - Key Exchange Box



- Key exchange box
- Designed to enable the release of keys by insertion of an initial key
- Releases up to 5 keys in any order
- Made for the usage in situations where multiple access points to the hazardous area are given
- Designed to be the link between the isolation units and access interlocks
- Supplied in an enclosure suitable for surface mounting
- Available with FS or Q type lock portions

Z-FSB-H-1/4

Application

A typical application of the Z key exchange box is machine guarding with one or more access points to the hazardous area. The key exchange box is used as a part of a safety system, which ensures a machine is shut down, before access to the hazardous area is allowed.

The system involves a KS key switch for the electrical supply and typically more than one AIE access interlocks for full body access. The removal of the isolation key from the key switch isolates the electrical supply to the machine. This key is taken to the Z key exchange box to release the trapped keys. The released keys are used to gain access through the AIE access interlocks.

The machine cannot be restarted until all keys are returned to the Z key exchange box and the power isolation key is released and replaced in the KS.

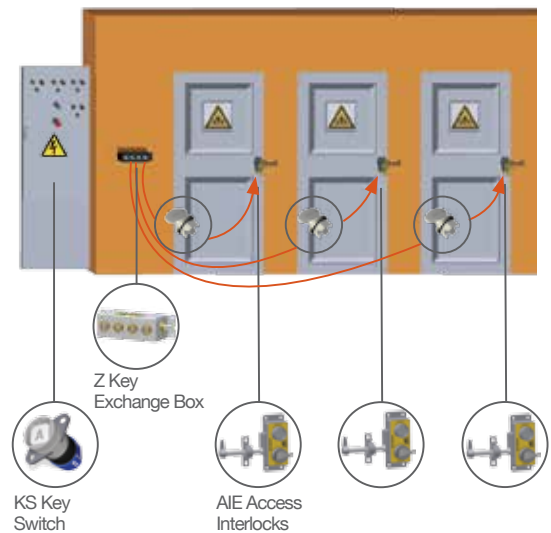

Order Information

	Product Type	1	2	3	4	5	6
Part Number	Z						
Example	Z	FS	B	H	1	4	TBA

1	Lock portion type	FS ⁽¹⁾ / Q ⁽¹⁾
2	Material	B = Brass S = Stainless steel
3	Mounting	H = Horizontal V = Vertical
4	Number of free keys (keys in)	Please specify ⁽¹⁾
5	Number of trapped keys (keys out)	Please specify ⁽¹⁾
6	Lock portion symbols: Please advise for each lock separately as end lock symbol (key in) and front lock symbols (keys out)	FS ⁽¹⁾ up to 3 characters / Q ⁽¹⁾ up to 6 characters

⁽¹⁾ Please see our glossary on pages 66-67 for more information

Please see our user manuals for more technical details and drawings, as well as mounting and maintenance information.

Y - Key Exchange Box



- Key exchange box
- Designed to enable the release of keys by insertion of an initial key
- Releases 6 or more keys (with no upper limit) in any order
- Made for the usage in situations where multiple access points to the hazardous area are given
- Designed as the link between the isolation units and access interlocks
- Supplied in an enclosure suitable for surface mounting
- Available with FS or Q type lock portions

Y-FSB-H-1/8

Application

A typical application of the Y key exchange box is machine guarding with more than one access points to the hazardous area. The key exchange box is used as a part of a safety system, which ensures a machine is shut down, before access to the hazardous area is allowed.

The system involves a KS key switch for the electrical supply and typically more than one AI access interlock for part body access. The removal of the isolation key from the key switch isolates the electrical supply to the machine. This key is taken to the Y key exchange box to release the trapped keys. The released keys are used to gain access through the AI door interlocks.

The machine cannot be restarted until all keys are returned to the Y key exchange box and the end key (power isolation key) is removed and taken to the KS.

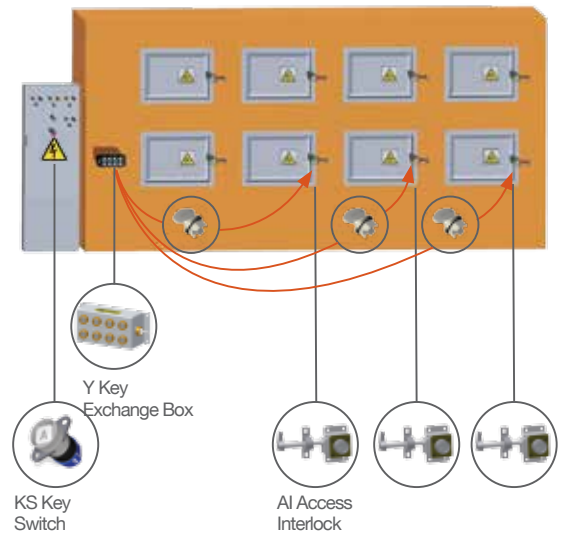

Order Information

	Product Type	1	2	3	4	5	6
Part Number	Y						
Example	Y	FS	B	H	1	8	TBA

1	Lock portion type	FS ⁽¹⁾ / Q ⁽¹⁾
2	Material	B = Brass S = Stainless steel
3	Mounting	H = Horizontal V = Vertical
4	Number of free keys	1, standard ⁽¹⁾
5	Number of trapped keys	Please specify ⁽¹⁾
6	Lock portion symbols: Please advise for each lock separately as end lock symbol (key in) and front lock symbols (keys out)	FS ⁽¹⁾ up to 3 characters / Q ⁽¹⁾ up to 6 characters

⁽¹⁾ Please see our glossary on pages 66-67 for more information

Please see our user manuals for more technical details and drawings, as well as mounting and maintenance information.

Key Exchange Boxes

W - Key Selector Box



- Key selector box
- Designed for a controlled release of keys by positioning of a selector knob
- Releases any number of keys in a pre-determined sequence in differing combinations
- Typically used in switchgear applications ensuring multiple supplies are not applied to common bus bars
- A maximum of 6 selector knob positions available
- Supplied in an enclosure suitable for surface mounting
- Available with FS or Q type lock portions

W-FSB-5/5P

Application

A typical application of the W key selector box is switchgear to ensure that multiple supplies are not applied to common bus bars.

In the application illustrated key I1 will operate incomer 1, key I2 will operate incomer 2 and key I3 will operate incomer 3. Key BC1 operates bus coupler 1 while key BC2 operates bus coupler 2. When the key is inserted, the corresponding switch is closed.

The system shown is in position 1 (see table) and has the three incomer switches closed and the busbar switches open. To change the system to condition 2 the I1 key is returned to the selector box and the selector knob moved to condition 2. In this position, the BC1 key can be removed and the BC1 Busbar switch closed.

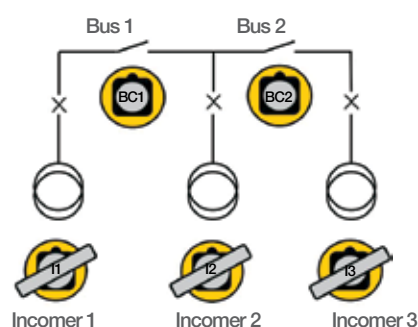

	I1	I2	I3	BC1	BC2
Pos 1	F	F	F	T	T
Pos 2	T	F*	F*	F	T
Pos 3	F	T	F*	F	T
Pos 4	F*	T	F*	T	F
Pos 5	F*	F	T	T	F

F = Free key
T = Trapped key (trapped in the W box)
* = key not returned between two neighbouring selections

Order Information

	Product Type	1	2	3	4	5
Part Number	W					
Example	W	FS	B	5	5P	TBA

1	Lock portion type	FS ⁽¹⁾ / Q ⁽¹⁾
2	Lock portion material	B = Brass S = Stainless steel
3	Number of lock portions	Please specify
4	Number of positions	Please specify
5	Truth table: Please provide	Please contact our technical support for assistance

⁽¹⁾ Please see our glossary on pages 66-67 for more information

Please see our user manuals for more technical details and drawings, as well as mounting and maintenance information.

What our customers say

"The quality of Castell Interlock systems are second to none. The products are robust and last for decades in the field"

Kieran Campbell, Installation Project Sources



Access to the hazardous area needs to be assessed as either part body or full body access. Once this is determined an access lock can be selected.

A part body access lock has only one lock and the isolation key is used to open this. Whilst the access lock is open the key cannot be removed and therefore the process cannot be started. Only once the lock is closed can the isolation key be removed and the process restarted.

Full body access locks have two locking mechanisms: The first step in the process is to insert the isolation key. This will allow the personnel key to be removed and then access can be granted by opening the bolt. The isolation key can only be removed once the personnel key has been inserted. Therefore whilst the personnel key is removed and the lock is open the process cannot be started. Only once the lock is closed and the personnel key returned can the isolation key be removed and the process restarted.

Access Control

Part Body Access

48

Full Body Access

54



Part Body Access

Salus - Automatic Access Interlock



- Single key automatic access interlock
- Designed for the use on hinged or sliding doors
- Available for left and right hinged or sliding door configurations
- Manufactured in stainless steel
- Ideal for use in harsh, corrosive environments and for heavy duty use

SALUS-S-1

Application

A typical application of the Salus single key automatic access interlock is machine guarding with part body access. The Salus is used as a part of a safety system, which ensures a machine is shut down, before access to the hazardous area is allowed.

The system involves the Salus20 key switch that breaks the machine safety circuit when the key is removed. The key can then be taken to the Salus automatic access interlock to enable access to the machine.

The machine cannot be restarted until the door is closed, the bolt is trapped in the Salus lock and the key is removed and taken to the Salus20.

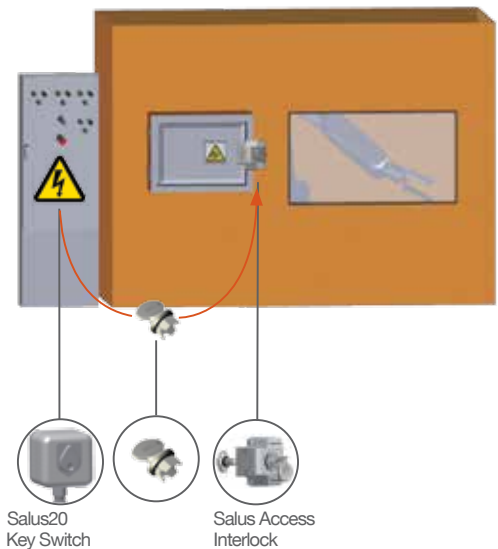

Order Information

	Product Type	1	2	3
Part Number	SALUS			
Example	SALUS	S	1	TBA

1	Operation	H = Hinged door operation S = Sliding door operation
2	Handing	1 = Left hinged door (bolt enters left) ⁽¹⁾ 2 = Right hinged door (bolt enters right) ⁽¹⁾
3	Lock portion symbol	Up to 3 characters (FS lock portion only) ⁽¹⁾

⁽¹⁾ Please see our glossary on pages 66-67 for more information

Please see our user manuals for more technical details and drawings, as well as mounting and maintenance information.

AI - Single Key Access Interlock

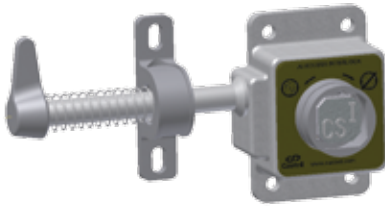

- Single key access interlock
- Ideal for use on hinged doors
- Has an open cavity design
- Manufactured in either aluminium alloy/brass or stainless steel
- Ideal for use in standard or harsh, corrosive environments and heavy duty use
- Shear force of bolt: 24KN

AI-FSS-1

Application

A typical application of the AI single key access interlock is machine guarding with part body access. The AI is used as a part of a safety system, which ensures a machine is shut down, before access to the hazardous area is allowed.

The system involves a KS key switch that breaks the machine safety circuit, when the key is removed. The key can then be taken to the AI access interlock to enable access to the machine.

The machine cannot be restarted until the door is closed, the bolt is replaced and the key is removed and taken to the KS.

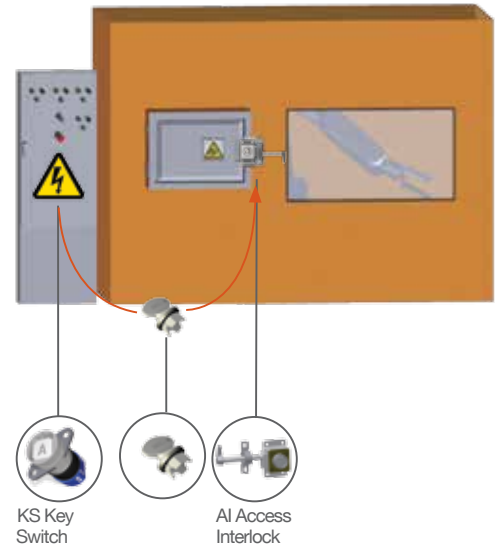

Order Information

	Product Type	1	2	3	4
Part Number	AI				
Example	AI	FS	S	1	TBA

1	Lock portion type	FS ⁽¹⁾ / Q ⁽¹⁾
2	Material	AL = Aluminium alloy/brass S = Stainless steel
3	Handing	1 = Left hinged door (bolt enters left) ⁽¹⁾ 2 = Right hinged door (bolt enters right) ⁽¹⁾
4	Lock portion symbol	FS ⁽¹⁾ up to 3 characters / Q ⁽¹⁾ up to 6 characters

⁽¹⁾ Please see our glossary on pages 66-67 for more information

Part Body Access

D - Panel Door Interlock



- Two-part panel door interlock
- Comprises of a lock body and a rear or front entry mounted catch
- Typically used for interlocking electrical control cubicles and distribution panels
- Also suitable for use on light access doors or hatches
- The catch is available in two options, suited to well aligned or misaligned doors
- Manufactured in either brass or stainless steel
- Ideal for use in standard or harsh, corrosive environments
- Available with FS or Q type lock portions

D-FSB-RE-MS-4

Application

The power supply to the system is switched on and the access doors to the hazardous area are locked closed.

The removal of the isolation key in the KSS, isolates the electrical supply to the LV Panel. This key is then used to unlock the D panel door interlock on the panel door.

The power cannot be switched on until the door is closed, the catch is trapped in the D panel door interlock and the key returned to the KSS.

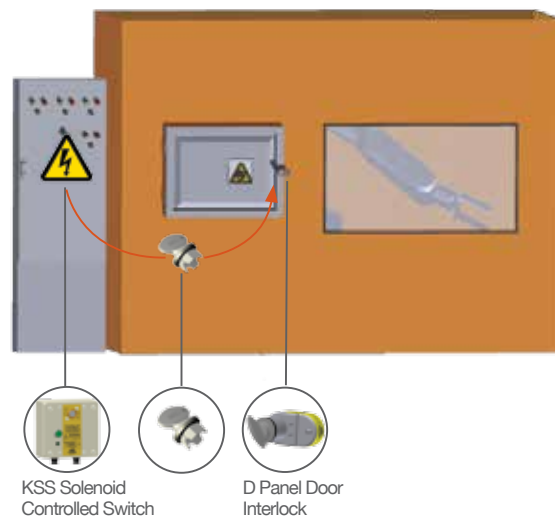

Order Information

	Product Type	1	2	3	4	5	6
Part Number	D						
Example	D	FS	B	RE	MS	4	TBA

1	Lock portion type	FS ⁽¹⁾ / Q ⁽¹⁾
2	Material	B = Brass / S = Stainless steel
3	Catch entry	RE = Rear entry / FR = Front entry
4	Catch type	STD = Standard catch, use for well aligned doors MS = Catch with spring, use for misaligned doors
5	Form	1 / 2 / 3 / 4 ⁽¹⁾
6	Lock portion symbol	FS ⁽¹⁾ up to 3 characters / Q ⁽¹⁾ up to 6 characters

⁽¹⁾ Please see our glossary on pages 66-67 for more information

Please see our user manuals for more technical details and drawings, as well as mounting and maintenance information.

KE - Sliding Door Interlock

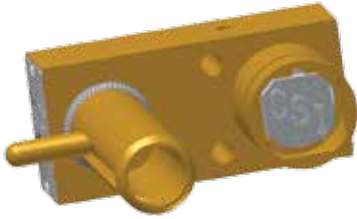

- One-piece access interlock
- Comprises of a main body and sliding bolt
- Designed to suit sliding doors of various sizes and dimensions
- Manufactured in brass
- Ideal for use in dry, non-corrosive environments where the lock is subject to medium to heavy duty use
- Available with FS or Q type lock portions
- Shear force of bolt: 30KN (stainless steel) and 19KN (brass)

KE-FSB-4-9mm

Application

The KE bolt interlocks are used as a part of a safety system, typically in machine guarding applications.

The power supply to the system is switched on and the access door to the hazardous area is locked closed.

The removal of the isolation key in the KS, isolates the electrical supply to the LV Panel. This key is then used to unlock the KE sliding door interlock on the sliding door.

The power cannot be switched on until the door is closed, the bolt is trapped in the KE sliding door interlock and the key returned to the KS.

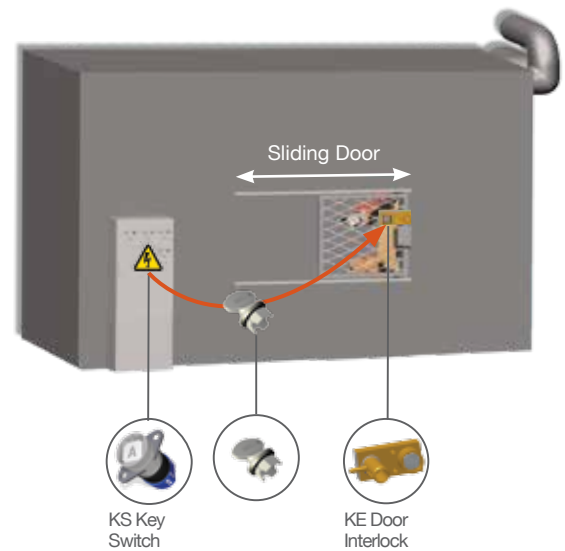

Order Information

	Type	1	2	3	4	5
Part Number	KE					
Example	KE	FS	B	4	9mm	TBA

1	Lock portion type	FS ⁽¹⁾ / Q ⁽¹⁾
2	Material	AL = Aluminium alloy/brass S = Stainless steel
3	Form	1 / 2 / 3 / 4 ⁽¹⁾
4	Door thickness	Please advise in mm
5	Lock portion symbol	FS ⁽¹⁾ up to 3 characters / Q ⁽¹⁾ up to 6 characters

⁽¹⁾ Please see our glossary on pages 66-67 for more information

Please see our user manuals for more technical details and drawings, as well as mounting and maintenance information.

Part Body Access



OLYMPUS-S24D-C24D

Olympus - Heavy Duty Solenoid Controlled Access Lock

- Heavy duty solenoid controlled access lock
- Designed for use on production cells and automated production and assembly lines where fast access is required
- The unit is locked by the solenoid when it is de-energised and opened when energised
- Ideal for all types of hinging or sliding access points
- Good tolerance for misaligned guarding
- Comes with the mechanical key override facility for the solenoid
- Capable of supporting category 4 safety systems through its 2N/C 1N/O contacts
- Available with either a stainless steel tongue actuator or a heavy duty handle

Application

A typical application of Olympus solenoid controlled access lock is machine guarding. It is usually connected to power isolators via safety relays.

When the machine is in operation the access door is locked via the de-energised solenoid in the Olympus solenoid controlled access lock. To open the guard, the machine is instructed to stop via the control circuit. Once the machine has completed the cycle, an external signal is received by the solenoid. Retracting the tongue actuator will break the contacts ensuring the power is locked out.

The machine cannot be restarted until the door is closed and the tongue actuator is replaced in the Olympus.



Olympus Solenoid Controlled Access Lock

Order Information

	Product Type	1	2	3	4
Part Number	OLYMPUS	S		C	
Example	OLYMPUS	S	24	D	C 24 D

1	Solenoid Voltage	24 / 48 / 110 / 240 V
2	Solenoid Current	D = DC / A = AC
3	Control Voltage	24 / 48 / 110 / 240 V
4	Control Current	D = DC / A = AC

⁽¹⁾ Please see our glossary on pages 66-67 for more information

Can be fitted with safety key adaptor to release personnel key

Please see our user manuals for more technical details and drawings, as well as mounting and maintenance information.



What our customers say

"We use Castell access locks on concrete-mixers where there are heavy duty lids, doors and hatches. All of these areas are exposed to both wet and dry concrete. The hinges on these doors are usually worn out fast and makes the door wobbly, but this is not a problem for Castell access locks. We also have instances where the locks have been completely encased in concrete. After they are chipped and lubricated, the locks still work fine. This shows us, how tough these access locks are."

Svein Erik Eliassen, OEM Automatic AS, Norway

Please see our user manuals for more technical details and drawings, as well as mounting and maintenance information.

Full Body Access



AIE - Dual Key Access Interlock

- Dual key access interlock
- Suitable for use on hinged and sliding doors
- The interlock has an open cavity design
- Manufactured in either aluminium alloy/brass or stainless steel
- Ideal for harsh or corrosive environments where the lock is subject to heavy duty use
- Available in an exchange or double key condition
- Shear force of bolt: 24KN

AIE-FSS-E-1

Application

A typical application of the AIE dual key access interlock is machine guarding with full body access. The AIE is used as part of a safety system, which ensures a machine is shut down, before access to the hazardous area is allowed.

The system involves a KS key switch for the electrical supply. The removal of the isolation key from the key switch isolates the electrical supply to the machine. This key is taken to the AIE and inserted into the lock. This allows the release of the personnel key and then the side bolt, which traps the isolation key. The personnel key is then taken into the area by the operative to safeguard themselves against accidental lock-in and start-up.

The machine cannot be restarted until the personnel key is returned, the bolt is replaced in the AIE and the isolation key is removed and taken to the KS.

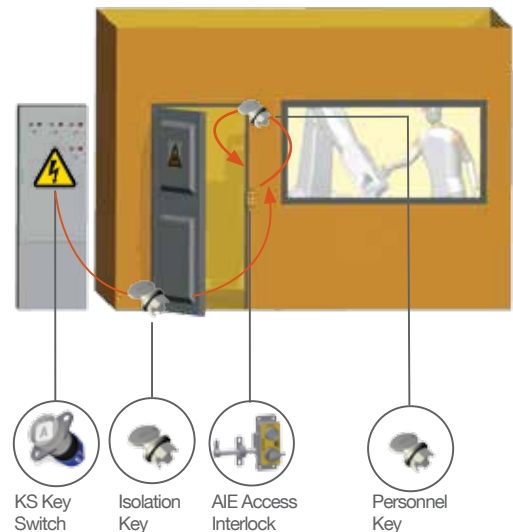

Order Information

	Product Type	1	2	3	4	5
Part Number	AIE					
Example	AIE	FS	S	E	1	TBA

1	Lock portion type	FS ⁽¹⁾ / Q ⁽¹⁾
2	Material	AL = Aluminium alloy/brass S = Stainless steel
3	Key Condition	E = Exchange key condition D = Double key condition (sequential removal of both keys)
4	Handing	1 = Left hinged door ⁽¹⁾ 2 = Right hinged door ⁽¹⁾
5	Lock portion symbol: Please advise for each lock portion separately as isolation key/lock symbol and personnel key/lock symbol	FS ⁽¹⁾ up to 3 characters / Q ⁽¹⁾ up to 6 characters

⁽¹⁾ Please see our glossary on pages 66-67 for more information

Please see our user manuals for more technical details and drawings, as well as mounting and maintenance information.

BD - Multi-key Panel Door Interlock

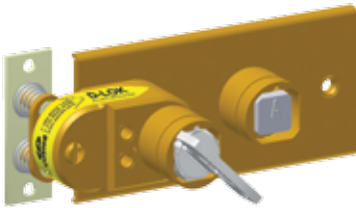

- Two-part access interlock
- Comprising of a main body and catch
- Complete with secondary lock portions
- The catch is available in two options, suited to both well aligned and mis-aligned doors
- Ideally suited for use on light duty panel doors, where the lock is subject to light to medium use
- Manufactured in brass
- Available with FS or Q type lock portions

BD-FSB-F-1S-E-RE-MS-4

Application

Castell BD multi-key panel door interlocks are used as a part of a safety system, typically in machine guarding applications as in the below example.

The power supply to the system is switched on and the access door to the hazardous area is locked closed. The removal of the isolation key in the KSS solenoid controlled key switch changes the switch contacts provided for electrical supply to the LV panel from closed to open. This key is then used to unlock the door by inserting key in the BD panel door interlock and releasing the trapped personnel key and then the catch. This will trap the isolation key in the BD interlock. The released key is taken by the personnel to the machine area.

The power cannot be switched on until the personnel key is returned, the door is closed, the catch is trapped in the BD panel door interlock and the isolation key returned to the KSS.

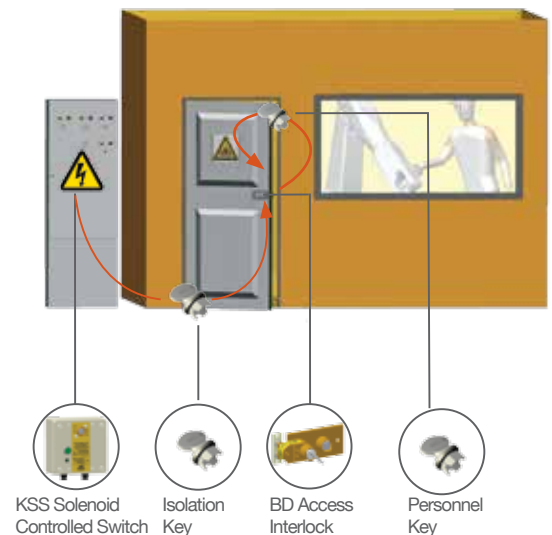

Order Information

	Product Type	1	2	3	4	5	6	7	8	9
Part Number	BD									
Example	BD	FS	B	F	1S	E	RE	STD	4	TBA

1	Lock portion type	FS ⁽¹⁾ / Q ⁽¹⁾
2	Material	B = Brass, standard
3	Mounting	P = Panel mount (back of board) F = Front of board mount, mounted on door surface
4	Secondary lock portion(s)	1S / 2S / 3S / 4S / 5S or 6S = 1 / 2 / 3 / 4 / 5 or 6 secondary lock portions respectively
5	Key condition	E = Exchange key condition (secondary key free, primary key trapped while catch is trapped) D = Double key condition (sequential removal of all keys with catch trapped)
6	Catch entry	RE = Rear entry / FR = Front entry ⁽¹⁾
7	Catch type	STD = Standard catch, use for well aligned doors MS = Catch with spring, use for misaligned doors ⁽¹⁾
8	Form	1 / 2 / 3 / 4 ⁽¹⁾
9	Lock portion symbols: Please advise for each lock portion separately as primary lock (next to the catch) / secondary lock (see also item 5)	FS ⁽¹⁾ up to 3 characters / Q ⁽¹⁾ up to 6 characters

⁽¹⁾ Please see our glossary on pages 66-67 for more information

Full Body Access



EDIX - Dual Key Access Interlock

- Dual key access interlock
- Complete with emergency exit system for use on hinged doors
- Manufactured in durable stainless steel
- Two internal crashbar options available:
A light duty two-point aluminium and a heavy duty three-point stainless steel
- Ideal for use in harsh or corrosive environments where it is subject to heavy duty use
- Available with FS or Q type lock portions

EDIX-FSS-BRI-1

Application

The EDIX is used as a part of a safety system to guard personnel when working within an area protected by a CO2 extinguishing system.

The safety system involves a KS key switch for the electrical supply to the extinguishing system controlling its operation mode. The removal of the key from the key switch changes the mode of the extinguishing system from automatic to manual. This key is then inserted in the MBV modular ball valve interlock fitted to the CO2 valve. With the key inserted, the valve is turned to the closed position, preventing the extinguishing system from being activated and allowing the removal of the secondary key from the MBV. This key is then inserted into the isolation lock on the EDIX and the personnel key removed. The door can now be opened by operating the handle. The personnel key is taken into the area by the operative. This prevents the ability of others to re-energise the extinguishing system while maintenance is being performed.

In case of an emergency the EDIX door lock can be overridden from the inside using the emergency exit crash bar.

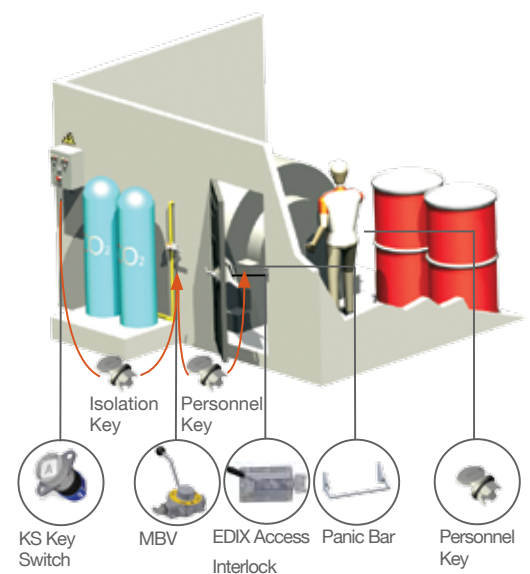

Order Information

	Product Type	1	2	3	4	5*	6
Part Number	EDIX						
Example	EDIX	FS	S	BRI	1	(LC)	TBA

1	Lock portion type	FS ⁽¹⁾ / Q ⁽¹⁾
2	Material	S = Stainless steel, standard
3	Crash bar type	SUR = SURELOCK McGill crash bar BRI = BRITON crashbar
4	Handing	1 = Left hinged door ⁽¹⁾ 2 = Right hinged door ⁽¹⁾
5*	Optional	LC = Less crash bar MS = M/S crash bar
6	Lock portion symbol: Please advise for each lock portion separately as isolation key/lock symbol and personnel key/lock symbol	FS ⁽¹⁾ up to 3 characters / Q ⁽¹⁾ up to 6 characters

⁽¹⁾ Please see our glossary on pages 66-67 for more information

Please see our user manuals for more technical details and drawings, as well as mounting and maintenance information.

KLE - Sliding Door Interlock



- Double key sliding door interlock
- One-piece access interlock comprising of a main body and sliding bolt
- Designed to suit sliding doors of various sizes and dimensions
- Manufactured in brass
- Ideal for use in dry, non-corrosive environments where the lock is subject to medium to heavy duty use
- Available with FS or Q type lock portions
- Comes as in a double key or exchange key condition
- Shear force of bolt: 30KN (stainless steel) and 19KN (brass)

KLE-FSB-1-E-50.8-4-9mm

Application

The KLE bolt interlocks are used as a part of a safety system, typically in machine guarding applications.

The power supply to the system is switched on and the access door to the hazardous area is locked closed. The removal of the isolation key in the KS unit isolates the electrical supply to the LV Panel. The key is then used to unlock the KLE sliding door interlock on the sliding door. This will release the second key (personnel key) which can be taken by personnel into the machine area.

The power cannot be switched on until the personnel key is returned to the access interlock, the door is closed, the bolt and key are trapped in the KLE unit and the isolation key returned to the KS.

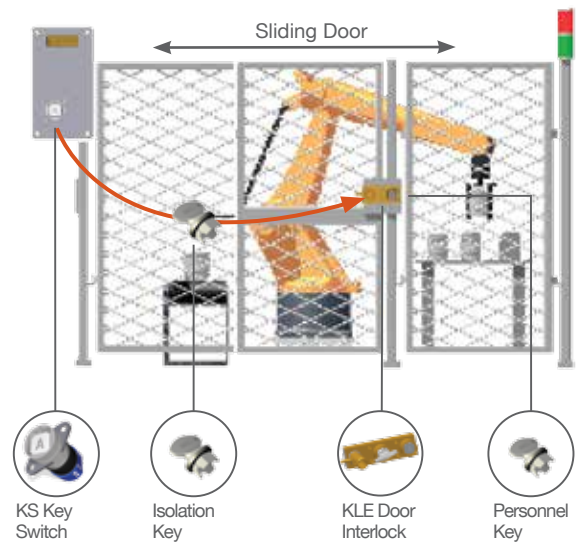

Order Information

	Product Type	1	2	3	4	5	6	7	8
Part Number	KLE								
Example	KLE	FS	B	1	E	50.8	4	9mm	TBA

1	Lock portion type	FS ⁽¹⁾ / Q ⁽¹⁾
2	Material	B = Brass, standard
3	Number of secondary lock portions	1, standard
4	Key condition	E = Exchange key condition D = Double key condition (sequential removal of all keys)
5	Bolt length	50,8 mm, standard
6	Form	1 / 2 / 3 / 4 ⁽¹⁾
7	Door thickness	Please advise in mm
8	Lock portion symbol: Please advise for each lock portion separately as isolation key/lock symbol and personnel key/lock symbol	FS ⁽¹⁾ up to 3 characters / Q ⁽¹⁾ up to 6 characters

⁽¹⁾ Please see our glossary on pages 66-67 for more information

Please see our user manuals for more technical details and drawings, as well as mounting and maintenance information.

Full Body Access



AIS-FSS-KF-1

AIS/Hercules - Access Interlock with Safety Switch

- Single key access interlock
- Complete with electrical contacts
- Suitable for use on hinged and sliding doors
- The switch is sealed to IP65 with 1N/O 2N/C contacts, rated to 6 A with bolt trapped
- Manufactured in stainless steel
- Ideal for use in corrosive and harsh environments and where the lock is subject to heavy duty use
- Available with FS or Q type lock portions
- Shear force of bolt: 24KN

Application

The Castell Hercules (AIS) access interlock with safety switch is used as a part of a safety system, typically in machine guarding applications.

The removal of the key from the AIS, isolates the electrical supply to the machine and allows the removal of the side bolt. Therefore the guard can only be opened when the electrical supply has been switched into a safe condition. This key is then taken into the area by the operative to safeguard against accidental lock-in or start-up or to initialize another part of the process, e. g. switching the machine into a teach mode.

The machine cannot be restarted until the door is closed, the bolt is trapped in the AIS access interlock and the key is replaced.

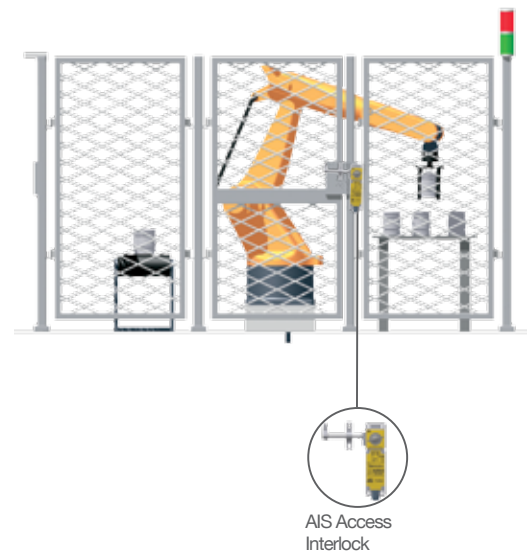

Order Information

	Product Type	1	2	3	4	5
Part Number	AIS					
Example	AIS	FS	S	KF	1	TBA

1	Lock portion type	FS ⁽¹⁾ / Q ⁽¹⁾
2	Material	S = Stainless steel, standard
3	Key condition (with bolt trapped)	KT = Key trapped while bolt trapped ⁽¹⁾ KF = Key free while bolt trapped ⁽¹⁾ - not to be used for full body access, use this condition for part body access
4	Handing	1 = Left hinged door (bolt enters left) ⁽¹⁾ 2 = Right hinged door (bolt enters right) ⁽¹⁾
5	Lock portion symbol	FS ⁽¹⁾ up to 3 characters / Q ⁽¹⁾ up to 6 characters

⁽¹⁾ Please see our glossary on pages 66-67 for more information



AIES-FSS-E-1

AIES - Dual Key Access Interlock with Safety Switch

- Dual key access interlock
- Complete with electrical contacts
- Suitable for use on hinged or sliding doors
- The contacts can be used to switch off the machine via its control circuitry or to initialise a signal to visual beacons/sounders
- The switch is sealed to IP65 with 1N/O 2N/C contacts, it is rated to 6 A
- Ideal for use in cross monitored safety systems
- Manufactured in a durable stainless steel
- Ideal for use in harsh or corrosive environments and where the lock is subject to heavy duty use
- Available in a double key or exchange key condition
- Shear force of bolt: 24KN

Application

A typical application of the AIES access interlock with safety switch is machine guarding with full body access. The AIES is used as part of a safety system, which ensures a machine is shut down, before access to the hazardous area is allowed.

The system involves a KS key switch for the electrical supply. The removal of the isolation key from the key switch isolates the electrical supply to the machine. This key is taken to the AIES and inserted into the lock. Turning the key changes the contacts in the AIES. Connected to a traffic light or another display it indicates the access to machine area can be gained. Rotating the isolation key also allows the release of the personnel key and then the side bolt, which traps the isolation key. The personnel key is then taken into the area by the operative to safeguard themselves against accidental lock-in and start-up.

The machine cannot be restarted until the personnel key is returned, the bolt is replaced in the AIES and the isolation key is removed and taken to the KS.

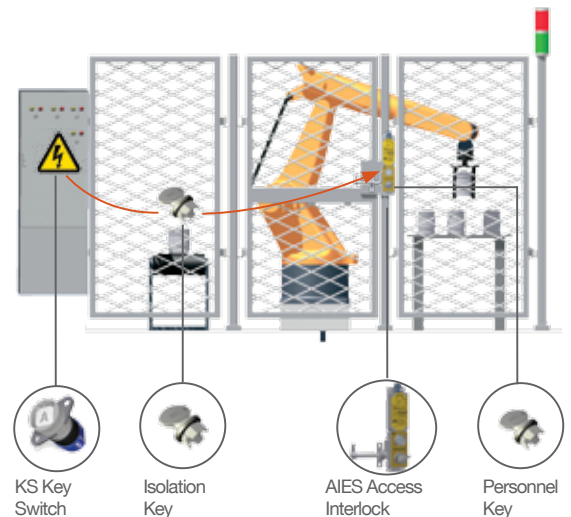

Order Information

	Product Type	1	2	3	4*	5	6
Part Number	AIES						
Example	AIES	FS	S	E	(KT)	1	TBA

1	Lock portion type	FS ⁽¹⁾ / Q ⁽¹⁾
2	Material	S = Stainless steel, standard
3	Key Condition 1	E = Exchange key condition D = Double key condition (sequential removal of both keys)
4*	Key condition 2 - in bolt trapped condition (applies for double key condition only, see item 3)	KT = Keys are trapped while bolt is trapped ⁽¹⁾ KF = Keys are free while bolt is trapped ⁽¹⁾
5	Handing	1 = Left hinged door ⁽¹⁾ 2 = Right hinged door ⁽¹⁾
6	Lock portion symbol: Please advise for each lock portion separately as isolation key/lock symbol and personnel key/lock symbol	FS ⁽¹⁾ up to 3 characters / Q ⁽¹⁾ up to 6 characters

⁽¹⁾ Please see our glossary on pages 66-67 for more information



A selection of keys is available to suit a range of applications, from the basic nickel plated key to the stainless steel sealing key. The FS range of keys fits the figure style lock portion whilst the Q range fits the Q style lock portion.

The flip cap provides both protection and the ability to use lockout tagout.

Keys & Accessories

Keys 62

Flip Cap 64



FS Keys - Figure Style Keys



FKW6-NI

- A selection of keys is available to suit a range of applications
- Stainless steel, brass and plated range of keys
- Customised coding: **SYMBOL (CODE) TO BE ADVISED WHEN ORDERING***:
 - ▶ Select up to 3 characters
 - ▶ Any alpha-numeric (A-Z) and (0-9) configurations
 - ▶ Do not use letter O, use zero instead
 - ▶ Do not use lower case
 - ▶ For spacing as a character advise TABLET (submaster key)*
- 47,988 code options available
- Master and submaster keys available*

Key Variations



FK4-NI /
FK4-MASTER



FKW6-S /
FKW6-S-MASTER



FKW6-NI



FKW3-RED



KSD-R



CL1062



006512



SHORT KEY/
FKV4-NI

Order Information

Part Number	Description
FK4 - NI	FK4 NICKEL PLATED KEY
FK4 - MASTER	FK4 MASTER KEY
FKW6 - S	FKW6 STAINLESS STEEL SEALING KEY
FKW6 - S - MASTER	FKW6 STAINLESS STEEL MASTER KEY
FKW6 - NI	FKW6 NICKEL PLATED SEALING KEY
FKW3 - RED	FKW3 T HANDLE SEALING KEY RED NYLON COATED
KSD -R	SWITCH DISCONNECTOR KEY
006512	SALVO KEY - FKW6-S KEY COMPLETE WITH ID TAG
CL1062	MERLIN GERIN KEY SK20165 MASTER PACT RANGE
SHORT KEY/FKV4-NI	SCHNEIDER AND ABB SWITCHGEAR APPLICATIONS KEY, NICKEL PLATED

Special keys available upon enquiry

***The disclaimer on page 63 applies when ordering master, submaster and spare keys.**

Please see our user manuals for more technical details and drawings, as well as mounting and maintenance information.

Q Keys - Q Style Keys



QS-NI

- A selection of keys is available to suit a range of applications
- Stainless steel, brass and plated range of keys
- Customised coding: **SYMBOL (CODE) TO BE ADVISED WHEN ORDERING***:
 - ▶ Select up to 6 characters
 - ▶ Any alpha-numeric (A-Z) and (0-9) configurations
 - ▶ Additional, non-alphanumeric characters available: (*), (/), (-) and ()
 - ▶ Do not use letter O, use zero instead
 - ▶ Do not use lower case
- Over 3.6 billion code options available
- Recorded in an internal data base to avoid duplications

Application



QS-S



QS-B



QS-NI

Order Information

Part Number	Description
QS - S	QS KEY - STAINLESS STEEL
QS - B	QS PLAIN BRASS Q KEY
QS - NI	QS KEY - NICKEL PLATED

Special keys available upon enquiry

***The disclaimer below applies when ordering master, submaster and spare keys.**

IMPORTANT - KEY DISCLAIMER:



We must draw your attention to the potential danger of issuing spare, master or submaster keys.

Trapped key interlocks control procedural events in a strict sequence.

If this sequence is altered through the use of spare or master keys, the integrity of your safety system may be compromised, possibly resulting in serious or even fatal injury to persons or damage to processes and plant.

In the wrong hands, spare or master keys could expose person(s) to the very hazard from which the interlocking system is intended to protect them.

Please see our user manuals for more technical details and drawings, as well as mounting and maintenance information.

Flip Cap

FLIP-S - Flip Cap



- Protective cap
- Used to prevent dust ingress into the Castell FS (figure style) lock portions
- Can be fitted with a padlock to prevent lock operation during maintenance

FLIP-S

Flip Cap



Order Information

Part Number

FLIP

-

S

Please see our user manuals for more technical details and drawings, as well as mounting and maintenance information.



For fast online orders, please visit

www.porta.castell.com

Fast, safe access 24/7



Glossary

A, B and D dimensions (KC and KLC)

Dimensions of the claw on the KC and KLC claw interlocks
Please see our user manuals to allocate and specify these dimensions (available at www.castell.com/downloads).

Catch entry (D and BD)

Entry point of the catch into a door lock (body):
RE = Rear entry
FR = Front entry

Catch type (D and BD)

STD = Standard catch, for well aligned doors
MS = MS type, for misaligned doors

Form (D, BD, K, KL, KF, KLF, KE, KLE, KP, KLP, KC and KLC)

Direction of the bolt, catch or a claw on a lock:

- Form 1 = Bolt/catch directs to the top
- Form 2 = Bolt/catch directs to the right
- Form 3 = Bolt/catch directs to the bottom
- Form 4 = Bolt/catch directs to the left

Forms: D

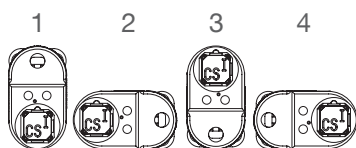

Forms: K, KL, KF and KLF

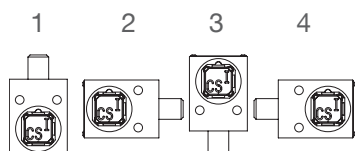

Forms: KE and KLE

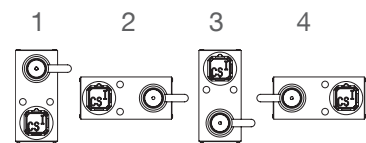

Forms: KP and KLP

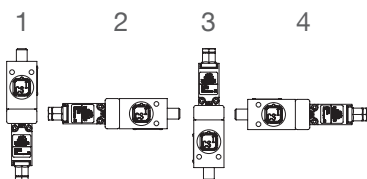

Forms: KC and KLC

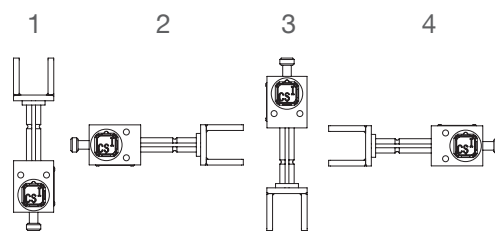

Handing (AI, AIE, Salus, AIS, AIES and EDIX)

Handing is defined by the position of the door hinge. Please follow the indications below for each product individually:

- Hand 1 = Left hinged door
- Hand 2 = Right hinged door

Handing: AI

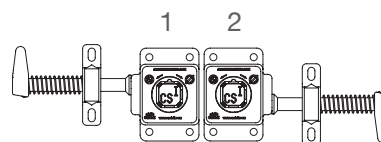

Handing: AIE

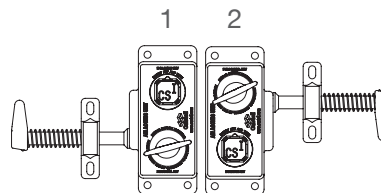

Handing: Salus

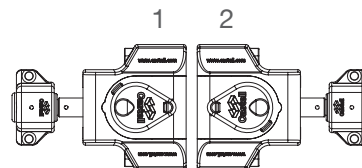

Handing: AIS

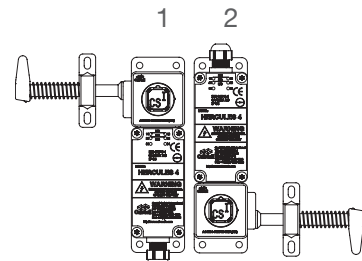

Please see our user manuals for more technical details and drawings, as well as mounting and maintenance information: www.castell.com/en/downloads

Handing: AIES

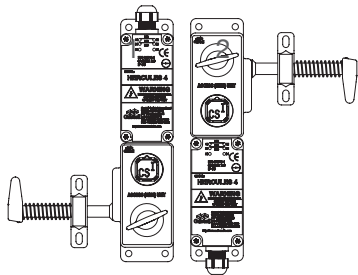

Handing: EDIX

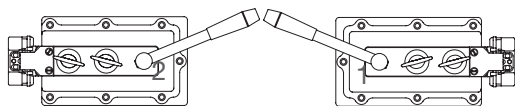

Key condition (KSE, KSSE, KL, KLF, KLC, KLP, AIE, BD, KLE and AIES)

Double or exchange key condition (dual or multi-key locks):

Double key condition = Sequential removal of all keys

Exchange key condition = Removal of one (or more) key(s) requires insertion of minimum one key, which remains trapped

KT or KF key condition (AIS and AIES)

describes the condition of the key (free or trapped) while bolt is trapped:

KT = Key trapped, while bolt is trapped

KF = Key free, while bolt is trapped

L dimension (K, KL, KF, KLF, KE, KLE, KP and KLP)

Length of the bolt in mm, in bolt retracted position

Standard L dimensions:

0 = 0 mm

6.4 = 6.35 mm

12.7 = 12.7 mm

19 = 19.05 mm

25 = 25.4 mm

Lock portion type (all products):

FS = Figure style lock portion

Q = Q style lock portion

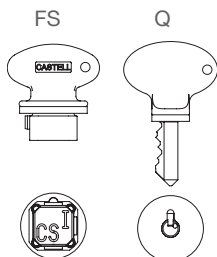

Material (all products)

B = Brass

S = Stainless steel

AL = Aluminium (alloy)

NI = Nickel

Mounting (KSD, KS, KSE, KSS, KSSE, TDI)

P = Panel mount / BOB (Back of Board)

F = Front of board, surface mount (product in enclosure)

Mounting (X, B, Z, Y, W)

H = Horizontal mount

V = Vertical mount

Mounting position (FS and Q locks)

1 = 45 degrees mount, clockwise

2 = 45 degrees mount, anti-clockwise

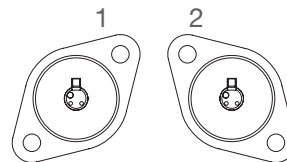

Switch entry (KP and KLP)

Switch entry point (KL/ KLP Interlock)

RE = Rear entry

FR = Front entry

Rotation movement (FS and Q locks)

CW = Clockwise

ACW = Anti-clockwise

Symbol (all products except Olympus)

Symbol = Individual coding of a lock/key that ensures the lock can only be opened with the corresponding key. Please see pages 62-63 for more information on key/lock symbols.

Valve locked state - LO, LC, LO/LC (MBV)

LO = Locked open valve state; LO-key free while valve is locked open

LC = Locked closed valve state; LC-key free while valve is locked closed

LO/LC = Locked open and locked closed, the valve can be locked in both, closed and open states.

Valve open state: LO-key free, LC-key trapped

Valve closed state: LC-key free, LO-key trapped

Please see our user manuals for more technical details and drawings, as well as mounting and maintenance information: www.castell.com/en/downloads

Product Overview

Power Isolation

KSD



Control Switching

Salus20



KS



KSE



Solenoid Controlled Switching

KSS



KSSE



KSUPS+



Time Delay Interlocking

DAE



TDI



TDR



Key Exchange Boxes

X



B



Y



Z



W



Part Body Access

Salus



AI



D



KE



Olympus



Motion Sensing

BEMF



MSI



Valve Interlocking

MBV



Mechanical Isolation

K



KL



KF



KLF

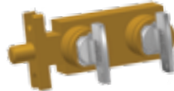

KC



KLC

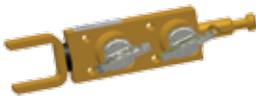

KP



KLP

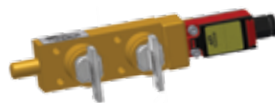

FS / Q



Full Body Access

AIE

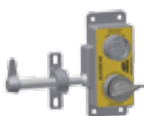

BD



EDIX



KLE



AIS/Hercules



AIES



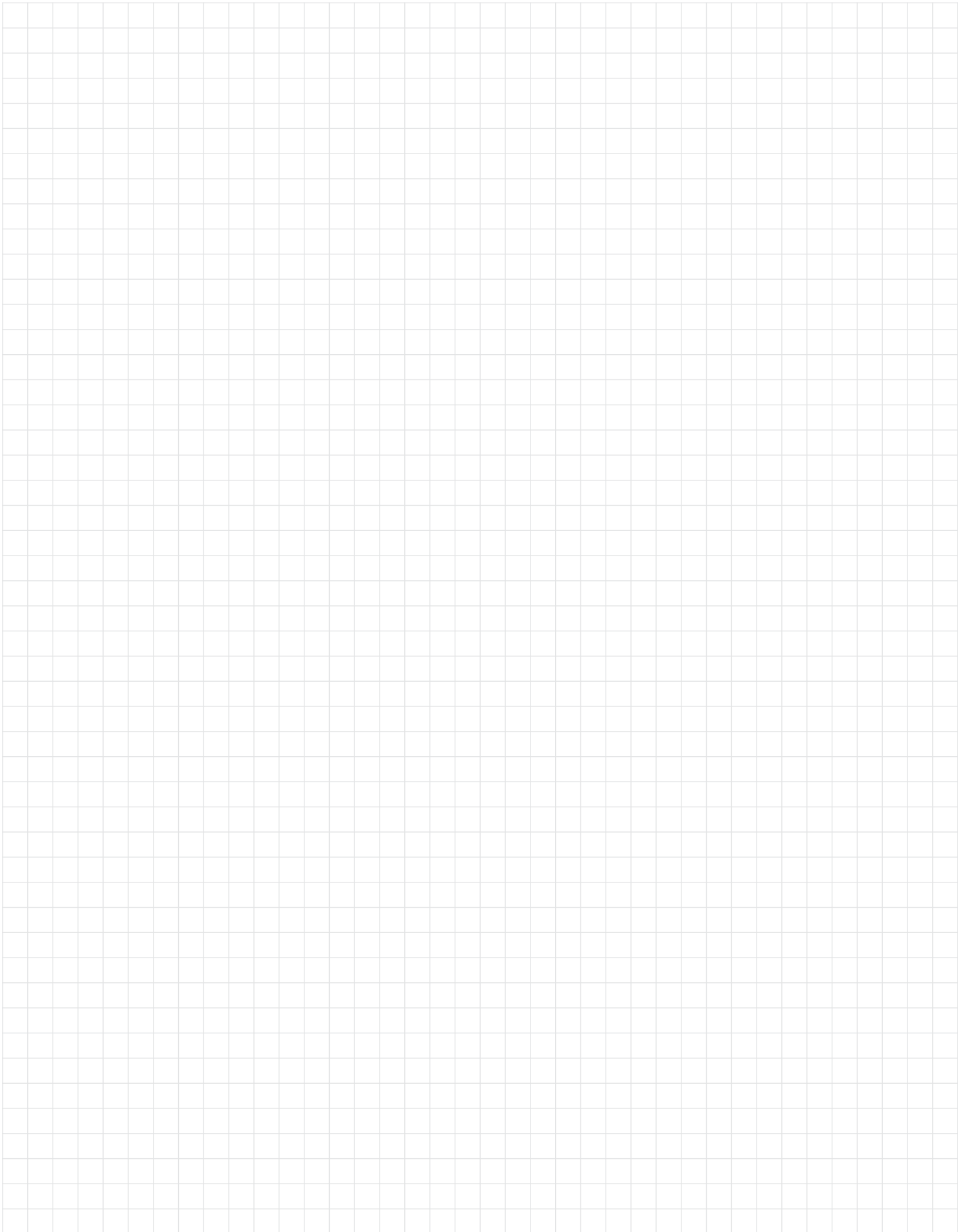





Castell

The Future of Safety is Here



Castell Safety International
The Castell Building
217 Kingsbury Road
London, NW9 9PQ
UK

t: +44 (0)20 8200 1200
f: +44 (0)20 8205 0055

uksales@castell.com
www.castell.com



Castell Safety International
Oskar-Jäger-Straße 137
50825 Köln
Germany

t: +49 (0)221 169 47 94
f: +49 (0)221 169 47 95

vertrieb@castell.com
www.castell.com



Castell Interlocks
150 N Michigan Avenue
Suite 800
Chicago IL 60601
USA

t: +1 (312) 360 1516
f: +1 (312) 268 5174

ussales@castell.com
www.castell.com



Castell Safety International
Building 1, No. 123
Lane 1165 Jindu Rd
Shanghai, 201108
China

t: +86 (0)21 6151 9028
f: +86 (0)21 6151 9030

chinasales@castell.com
www.castell.com



Castell Safety International
No.14, 7th Street, R.E. Nagar
Porur, Chennai - 600116
Tamil Nadu
India

t: +91 (0)98406 31258
f: +44 (0)20 8205 0055

indiasales@castell.com
www.castell.com

A HALMA COMPANY

